

# Section 1 Trolleys & Hand Trucks



**FREECALL 1800 750 900**  
**[www.mhaproducts.com.au](http://www.mhaproducts.com.au)**



# V-Cart Folding Plastic and Aluminium Trolley

- The V-Cart is a collapsible trolley that can be used for hundreds of applications.
- It is ideal for use in the workplace, schools, home, office, hospitals, courier services, shopping malls, nursing homes as much more!
- It can be completely collapsed by the push of a button on the handle. The wheels are able to be removed by the push of a button and stored underneath for compact transport and storage.
- The V-Cart is supplied with one collapsible basket which will lock into place on either the top or bottom platform.
- The top platform can be folded back to allow larger items to be transported if required.
- Features support bars that give added stability to the top platform
- Extra baskets are available for use on both platforms or up to 4 baskets can be stacked on the bottom platform.
- A robust foot pedal brake allows the V-Cart to be locked in position whilst loading or unloading.
- The injection moulded plastic and aluminium design means that whilst the V-Cart is lightweight it is still very robust and has a great carrying capacity.
- The basket fits foolscap suspension files, which is great for transporting documents throughout the office.
- The V-Cart can also be used with our standard No.7, No.10.No.15 tubs



## Specifications

- Total Trolley Capacity: 90kg
- Top Shelf Capacity: 40kg
- Bottom Shelf Capacity: 50kg
- Trolley Weight: 10kg
- Basket Weight: 1.8kg
- Handle Height: 1050mm

## Dimensions

- Overall Length Assembled: 1000mm
- Overall Width Assembled: 600mm
- Overall Height Assembled: 1070mm
- Overall Length Folded: 740mm
- Overall Width Folded: 540mm
- Overall Height Folded: 105mm

# V-CART»»



View video of this in operation here [www.mhaproducts.com.au/vcart](http://www.mhaproducts.com.au/vcart)



Extra Basket (M1805)



Hard Lid to suit Basket (M1806)



Rain Cover (M1810)



Tool Bin (M1815)

Code	Details
M1800	V-Cart Folding Plastic & Aluminium Trolley (Includes 1 Folding Basket)
M1805	V-Cart Extra Basket
M1806	Lid to suit V-Cart Basket
M1810	V-Cart Vinyl Cover
M1815	V-Cart Tool Bin



# Customise your V-Cart with accessories

*V-Cart pictured with additional basket and tool bin*



## Multi-Purpose Platform Trolleys (Folding Handle)

- Powder coated steel construction with vinyl decks
- Surround bumper on perimeter of trolley
- Rubber castors - 2 x fixed, 2 x swivel



Code	Load Capacity (kg)	Castors (mm)	Handle Height (mm)	Platform Size (mm)	Platform Height (mm)	Unit Weight (kg)
M1000	150	100	860	740x480	150	12
M1001	250	125	860	920x610	180	18

## Multi-Purpose Platform Trolleys (Fixed Handle)

- Powder coated steel construction with vinyl decks
- Surround bumper on perimeter of trolley
- Rubber castors - 2 x fixed, 2 x swivel



Code	Details	Load Capacity (kg)	Castors (mm)	Handle Height (mm)	Platform Size (mm)	Platform Height (mm)	Unit Weight (kg)
M1012	1 Handle	300	160	860	1150x750	240	35
M1013	2 Handle	300	160	860	1150x750	240	40



## Prestige Platform Trolleys

- Powder coated steel construction with vinyl decks
- Surround bumper on perimeter of trolley
- M1002 has a folding handle for compact storage when not in use
- Polyurethane castors - 2 x fixed, 2 x swivel
- Platform Height: 190mm



M1002



M1010



M1011



Brake Kit (M1005)

Code	Details	Load Capacity (kg)	Castors (mm)	Handle Height (mm)	Platform Size (mm)	Overall Size LxWxH (mm)	Unit Weight (kg)
M1002	1 Folding Handle	370	125	1000	880x580	915x615x865	17
M1010	1 Fixed Handle	370	125	1000	880x580	945x615x870	16
M1011	2 Fixed Handle	370	125	1000	880x580	965x615x870	20
M1005	Brake Kit to suit M1002, M1010 and M1011						

## Extra Large Prestige Platform Trolley

- Powder coated steel construction with vinyl decks
- Surround bumper on perimeter of trolley
- Polyurethane castors - 2 x fixed, 2 x swivel
- Optional pneumatic wheel kit - includes 2 x fixed wheels and 2 x swivel wheels with brakes



Extra Handle (M1016)



Pneumatic Wheel Kit (M1845)



Code	Details	Load Capacity (kg)	Castors (mm)	Handle Height (mm)	Platform Size (mm)	Platform Height (mm)	Unit Weight (kg)
M1015	XL Platform Trolley	650	200	1000	1125x720	245	40
M1016	Optional Extra Handle						
M1845	Pneumatic Wheel Kit						



## Heavy Duty Steel Platform Trolleys

- Heavy duty steel platform trolleys are ideal for general warehouse use
- Available in 3 sizes
- Welded steel construction
- Durable baked enamel paint finish
- Rubber castors - 2 x fixed, 2 x swivel with brakes



Code	Load Capacity (kg)	Castors (mm)	Overall Length (mm)	Handle Height (mm)	Platform Size (mm)	Platform Height (mm)	Unit Weight (kg)
M1040	540	200	1020	970	920x610	290	32
M1041	540	200	1320	970	1220x610	290	36
M1043	540	200	1620	970	1520x760	290	49

## Heavy Duty Aluminium Platform Trolleys

Strong and lightweight aluminium platform trolleys which are great for general transportation of goods around warehouses, shopping centres and courier goods delivery.

- Lightweight and corrosion resistant
- Highly manoeuvrable & heavy duty construction
- Checker plate deck
- Removable handles (comes standard with 1 Handle)
- 3 standard sizes available
- Polyurethane castors - 2 x fixed, 2 x swivel with brakes
- Optional flat free wheel kit available - 2 x fixed wheels and 2 x swivel wheels with brakes

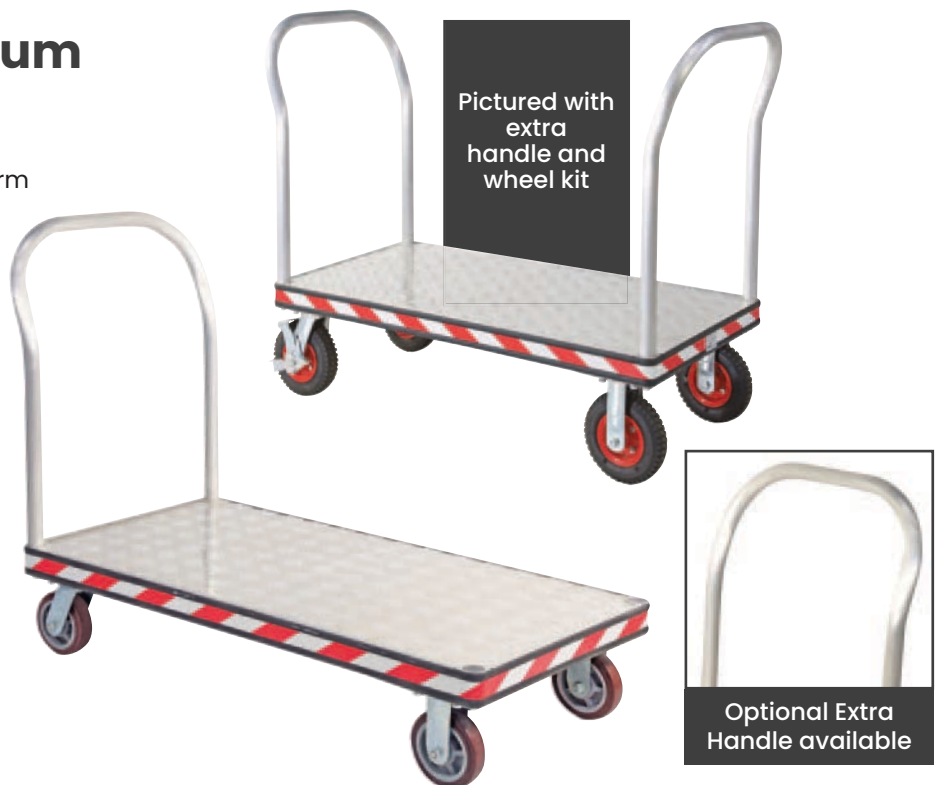

Code	Details	Load Capacity (kg)	Castors (mm)	Handle Height (mm)	Platform Size (mm)	Platform Height (mm)	Unit Weight (kg)
M1050	Platform Trolley	500	125	1010	930x620	260	22
M1051	Platform Trolley	500	125	1010	1230x620	260	25
M1052	Platform Trolley	500	125	1010	1530x770	260	30
M1053	Optional 2nd Handle to suit M1050 & M1051						
M1054	Optional 2nd Handle to suit M1052						
M1055	Flat Free Wheel Kit						



## Foldable Plastic Deck Trolley

- Folding aluminium and plastic trolley ideal for retail areas, office areas, delivery vans and transporting lightweight goods
- Extremely lightweight and compact trolley which folds flat
- The trolley also fits the V-Cart Folding Basket (see page 8)
- Hard clip-on lid available for the V-Cart Basket
- 3 Handle heights: 725mm, 825mm and 925mm
- Rubber castors - 2 x fixed, 2 x swivel
- Platform Height: 180mm
- Platform Size: 670x405mm



Extra Basket (M1805)



Hard Lid to suit Basket (M1806)

Code	Details	Load Capacity (kg)	Castors (mm)	Folded Size LxWxH (mm)	Open Size LxWxH (mm)	Unit Weight (kg)
M1197	Foldable Plastic Deck Trolley	137	100	670x405x80	670x405x925	6
M1805	V-Cart Extra Basket					
M1806	Lid to suit V-Cart Basket					

## Nestable Stock Trolley

- The Nestable Stock Trolley is ideal for transporting heavy boxes and other product long and awkward items, due to its open platform design and quality construction.
- Platform folds up for nesting
- Electro galvanised construction and powder coated handles
- Rubber castors - 4 x swivel



Code	Load Capacity (kg)	Castors (mm)	Platform Size (mm)	Overall Size LxWxH (mm)	Unit Weight (kg)
M1260	200	125	850x600	1170x700x980	22



## Heavy Duty Single Handle Platform Trolley

- Bolt together steel construction (supplied flatpack)
- Powder coated blue
- Rubber castors - 2 x fixed, 2 x swivel with brakes
- Optional flat free wheel kit available - 2 x fixed wheels and 2 x swivel wheels with brakes
- Load Capacity (with flat free wheel kit): 350kg
- Handle Height: 1000mm
- Platform Height: 230mm



Code	Load Capacity (kg)	Castors (mm)	Platform Size (mm)	Overall Size LxWxH (mm)	Unit Weight (kg)
M1850	500	160	1100x600	1200x610x990	48



## Heavy Duty Double Handle Platform Trolley

- Bolt together steel construction (supplied flatpack)
- Powder coated blue
- Rubber castors - 2 x fixed, 2 x swivel with brakes
- Optional flat free wheel kit available - 2 x fixed wheels and 2 x swivel wheels with brakes
- Load Capacity (with flat free wheel kit): 350kg
- Handle Height: 1000mm
- Platform Height: 230mm

Code	Load Capacity (kg)	Castors (mm)	Platform Size (mm)	Overall Size LxWxH (mm)	Unit Weight (kg)
M1860	550	160	1100x600	1305x610x990	53

## Heavy Duty 2 Tier Platform Trolley

- Bolt together steel construction (supplied flatpack)
- Powder coated blue
- Top platform and extra shelves can be used as flat shelf or turned upside down to be used as a tray
- Additional shelf available to make it multi-tier
- Rubber castors - 2 x fixed, 2 x swivel with brakes
- Optional flat free wheel kit available - 2 x fixed wheels and 2 x swivel wheels with brakes
- Handle Height: 1000mm
- Platform Heights: 230mm + 720mm



Code	Load Capacity (kg)	Castors (mm)	Platform Size (mm)	Overall Size LxWxH (mm)	Unit Weight (kg)
M1862	500	160	1100x600	1305x610x990	66





# Accessories to suit Platform Trolleys

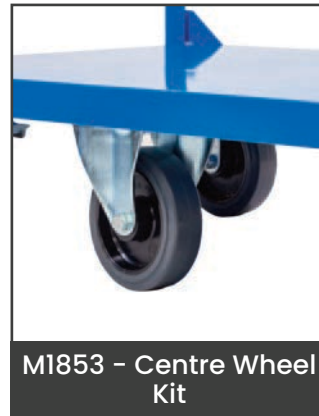

Code	Details
M1840	Drink Holder
M1841	Clipboard Holder
M1842	Laptop & RF Scanner Holder
M1843	Mesh Basket Accessory Tray
M1844	Accessory Shelf
M1848	A4 Pocket
M1849	Scanner Holder
M1852	Extra Shelf (Only Suits M1862)
M1853	Centre Wheel Kit with Swivel Brake
M1845	Flat Free Wheel Kit (includes 2 swivel wheels with brakes and 2 fixed wheels)

# Powered Platform Trolley

These powered heavy duty platform trolleys provide a strong 400kg capacity platform to move heavy items around your workplace.

- Comes with a removable cage (as pictured) to avoid items falling off while moving.
- Platform has an anti-slip grip so that items don't slide off easily in transit.
- Rubber bumper edge
- Emergency stop button
- Comes with forward and reverse drive options
- Variable speed controller
- Powered by 2 x 12V / 33Ah batteries
- 2 x swivel castors
- 2 x pneumatic drive wheels
- Clearance From Battery Box to Ground: 65mm
- Electro magnetic brake
- Cage Height: 930mm
- Moving Speed: 5-8km/h



Code	Load Capacity (kg)	Front Wheels (mm)	Rear Castors (mm)	Handle Height (mm)	Platform Size (mm)	Platform Height (mm)	Overall Size LxWxH (mm)	Unit Weight (kg)
M1065	400	260	150	1080	1290x640	320	1420x630x1090	110



See page 172



See page 172



See page 173



# Powered Dump Truck

- Great for dirt, bark and rubbish removal in outdoor areas
- Emergency stop button
- Forward and reverse drive
- Variable speed controller
- Powered by 3 x 12V / 55Ah batteries
- Pneumatic wheels
- Moving Speed: 5-8km/h
- Lift Time: 15 secs
- Lift Angle: 45 degrees
- Electro magnetic brake



Watch a video of this in operation on our website here, [www.mhaproducts.com.au/M1067](http://www.mhaproducts.com.au/M1067)



Code	Load Capacity (kg)	Wheels (mm)	Handle Height (mm)	Tray Height from Ground (mm)	Tray Size LxWxH (mm)	Overall Size LxWxH (mm)	Unit Weight (kg)
M1067	800	325	1000	740	1510x800x310	2250x810x1070	250

# Large Powered Platform Trolley

- Great for both indoor and outdoor use with high load capacity
- Platform has an anti-slip grip so that items don't slide off easily in transit
- Rubber bumper edge
- Supplied with removable cage
- Emergency stop button
- Forward and reverse drive
- Variable speed controller
- Powered by 3 x 12V / 55Ah batteries
- Pneumatic wheels
- Clearance From Battery Box to Ground: 75mm
- Moving Speed: 5-8km/h
- Electro magnetic brake



Supplied standard with removable cage to prevent items falling off during transit



Code	Load Capacity (kg)	Wheels (mm)	Handle Height (mm)	Platform Size (mm)	Platform Height (mm)	Overall Size With Cage LxWxH (mm)	Unit Weight (kg)
M1066	800	310	950	1400x900	385	2070x900x980	170



## Multi-Purpose 2 Tier Trolleys

- General purpose industrial quality 2 tier trolleys for goods movement
- Powder coated steel construction with vinyl decks
- Surround bumper on perimeter of trolley
- M1020 - Rubber castors - 2 x fixed, 2 x swivel
- M1021 - Polyurethane castors - 2 x fixed, 2 x swivel



Brake Kit (M1005)



M1020



M1021

Code	Details	Load Capacity (kg)	Castors (mm)	Handle Height (mm)	Shelf Size (mm)	Shelf Heights (mm)	Unit Weight (kg)
M1020	2 Tier Trolley	120	100	860	750x490	140 + 660	20
M1021	2 Tier Trolley	370	125	1000	920x620	180 + 780	27
M1005	Brake Kit to suit M1021						

## Multi-Purpose 3 Tier Trolleys

- General purpose industrial quality trolleys for transporting goods safely in the workplace
- Powder coated steel construction with vinyl decks
- Surround bumper on perimeter of trolley
- M1025 - Rubber castors - 2 x fixed, 2 x swivel
- M1026 - Polyurethane castors - 2 x fixed, 2 x swivel

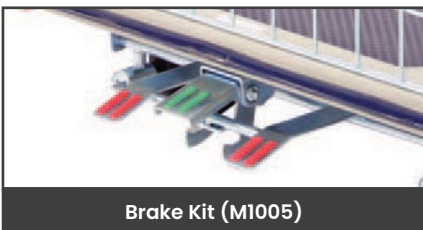

Brake Kit (M1005)



M1026



M1025

Code	Details	Load Capacity (kg)	Castors (mm)	Handle Height (mm)	Shelf Size (mm)	Shelf Heights (mm)	Unit Weight (kg)
M1025	3 Tier Trolley	120	100	860	740x480	140 + 410 + 660	26
M1026	3 Tier Trolley	370	125	990	920x620	180 + 480 + 780	36
M1005	Brake Kit to suit M1026						



### 3 Tier Multi Shelf Trolley

- 3 Tiered Multi Shelf Trolley is ideal for order picking and transporting goods in the workplace
- Suitable for use in retail and industrial applications
- The shelves can be used as a flat platform or turned upside down and used as a tray
- Powder coated finish
- Available in Blue or White
- Overall Size (LxWxH): 1080x480x940mm
- Rubber castors - 2 x swivel, 2 x swivel with brakes

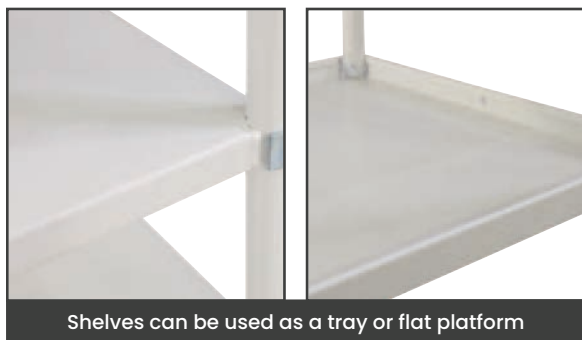

Code	Details	Load Capacity (kg)	Castors (mm)	Shelf Size (mm)	Distance Between Shelves (mm)	Height to Top Shelf (mm)	Unit Weight (kg)
M1660	Blue	250	125	900x440	250	760	30
M1661	White	250	125	900x440	250	760	30

### Tall Multi Shelf Trolley

- The multi tier shelf trolley is ideal for order picking & transporting goods in the workplace
- Suitable for use in retail & industrial applications
- Supplied standard with 3 shelves (extra shelves available)
- The shelves can be used as a flat platform or turned upside down and used as a tray
- Powder coated finish
- Available in Blue or White
- Overall Size (LxWxH): 980x585x1445mm
- Rubber castors - 2 x swivel, 2 x swivel with brakes



Code	Details	Load Capacity (kg)	Castors (mm)	Shelf Size (mm)	Height to Top Shelf (mm)	Unit Weight (kg)
M1662	Blue	250	125	900x540	1340	39
M1663	Extra Shelf to Suit M1662					
M1664	White	250	125	900x540	1340	39
M1665	Extra Shelf to Suit M1664					



## 2 Tier Steel Trolley

- Simple bolt together construction
- Powder coated blue finish
- Reversible top shelf which gives a tray option
- Rubber castors - 2 x fixed, 2 x swivel with brakes
- Many accessories available to suit - see page 25
- Internal Tray Size: 905x600mm
- Distance between shelves: 665mm

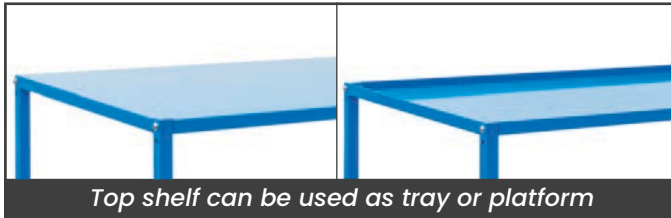

Code	Load Capacity (kg)	Castors (mm)	Handle Height (mm)	Overall Size LxWxH (mm)	Shelf Size (mm)	Shelf Heights (mm)	Unit Weight (kg)
M1880	300	125	1050	1095x660x1050	960x655	184 + 875	33

## 3 Tier Steel Trolley

- Simple bolt together construction
- Powder coated blue finish
- Middle shelf is removable if not required
- Reversible top and middle shelf which gives a tray option
- Rubber castors - 2 x fixed, 2 x swivel with brakes
- Many accessories available to suit - see page 25
- Internal Tray Size: 905x600mm
- Distance between shelves: 313mm

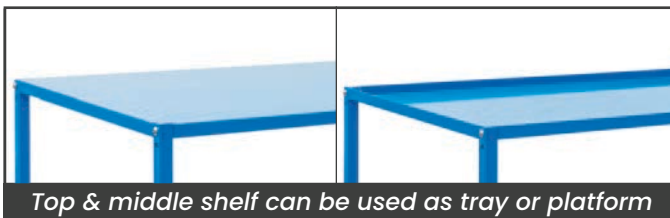

Code	Load Capacity (kg)	Castors (mm)	Handle Height (mm)	Overall Size LxWxH (mm)	Shelf Size (mm)	Shelf Heights (mm)	Unit Weight (kg)
M1881	300	125	1050	1095x660x1050	960x655	184 + 530 + 875	42



## 2 Tier Steel Tub Trolley

- Simple bolt together construction
- Powder coated blue finish
- Supplied standard with no tubs
- Fits a variety of tubs - see online for more details
- Bin colours: Black, Red, Blue, Green, Yellow & White
- Rubber castors - 2 x fixed, 2 x swivel with brakes
- Many accessories available to suit - see page 25
- Distance between shelves: 665mm
- M1882K pictured - which comes with 4x No. 4D Recycled Plastic Black Bins



Accessories available to suit - See page 25

Code	Details	Load Capacity (kg)	Castors (mm)	Handle Height (mm)	Overall Size LxWxH (mm)	Shelf Size (mm)	Base Height (mm)	Unit Weight (kg)
M1882	2 Tier Tub Trolley	300	125	1050	1095x660x1050	960x655	184	36
M1882K	2 Tier Tub Trolley - Supplied with 4 x No 4D Black Tubs							

## 3 Tier Steel Tub Trolley

- Simple bolt together construction
- Powder coated blue finish
- Supplied standard with no tubs
- Fits a variety of tubs - see online for more details
- Bin colours: Black, Red, Blue, Green, Yellow & White
- Tubs sit inside rails
- Rubber castors - 2 x fixed, 2 x swivel with brakes
- Many accessories available to suit - see page 25
- Distance between shelves with no tubs: 665mm
- M1883K pictured - which comes with 8x No. 4D Recycled Plastic Black Bins



Accessories available to suit - See page 25

Code	Details	Load Capacity (kg)	Castors (mm)	Handle Height (mm)	Overall Size LxWxH (mm)	Shelf Size (mm)	Base Height (mm)	Unit Weight (kg)
M1883	3 Tier Tub Trolley	300	125	1050	1095x660x1050	960x655	184	40
M1883K	3 Tier Tub Trolley - Supplied with 8 x No 4D Black Tubs							



### 3 Tier Multi-Tub Trolley

- Simple bolt together construction
- Powder coated blue finish
- Supplied standard with no tubs
- Fits a variety of tubs - see online for more details
- Bin colours: Black, Red, Blue, Green, Yellow & White
- Tubs sit in channels as pictured
- Rubber castors - 2 x fixed, 2 x swivel with brakes
- Many accessories available to suit - see page 25
- M1884K pictured - which comes with 4x No. 10 Recycled Plastic Black Bins



Accessories available to suit - See page 25

Code	Details	Load Capacity (kg)	Castors (mm)	Handle Height (mm)	Overall Size LxWxH (mm)	Shelf Size (mm)	Base Height (mm)	Unit Weight (kg)
M1884	3 Tier Multi-Tub Trolley	300	125	1050	1095x660x1050	960x655	184	38
M1884K	3 Tier Multi-Tub Trolley - Supplied with 4 x No 10 Black Tubs							

### 2 Tier Single Basket Trolley

- Simple bolt together construction
- Powder coated blue finish
- Mesh basket as top tray with 25mm punch holes
- Rubber castors - 2 x fixed, 2 x swivel with brakes
- Many accessories available to suit - see page 25
- Clearance from shelf to underside of basket: 460mm
- Basket Size (LxWxH): 905x600x225mm



Accessories available to suit - See page 25

Code	Load Capacity (kg)	Castors (mm)	Handle Height (mm)	Overall Size LxWxH (mm)	Shelf Size (mm)	Base Height (mm)	Unit Weight (kg)
M1885	300	125	1050	1095x660x1050	960x655	184	39





## 2 Tier Double Basket Trolley

- Simple bolt together construction
- Powder coated blue finish
- Mesh basket as top tray with 25mm punch holes
- Rubber castors - 2 x fixed, 2 x swivel with brakes
- Many accessories available to suit - see page 25
- Bottom mesh basket can be removed if not required
- Distance between baskets: 230mm
- Basket Size (LxWxH): 905x600x225mm

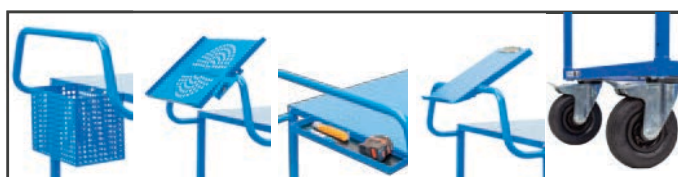

Accessories available to suit - See page 257

Code	Load Capacity (kg)	Castors (mm)	Handle Height (mm)	Overall Size LxWxH (mm)	Shelf Size (mm)	Unit Weight (kg)
M1886	300	125	1050	1095x660x1050	960x655	36

## 2 Tier Deep Basket Trolley

- Simple bolt together construction
- Powder coated blue finish
- Mesh basket as top tray with 25mm punch holes
- Rubber castors - 2 x fixed, 2 x swivel with brakes
- Many accessories available to suit - see page 25
- Clearance from shelf to underside of basket: 313mm
- Basket Size (LxWxH): 905x600x375mm

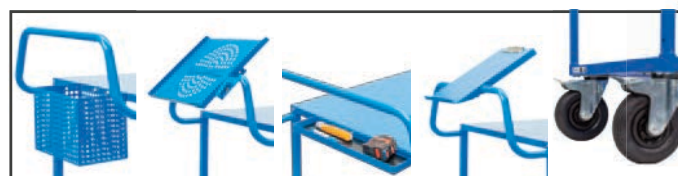

Accessories available to suit - See page 25

Code	Load Capacity (kg)	Castors (mm)	Handle Height (mm)	Overall Size LxWxH (mm)	Shelf Size (mm)	Base Height (mm)	Unit Weight (kg)
M1893	300	125	1050	1095x660x1050	960x655	184	42



## 2 Tier Rubber Top Trolley

- Simple bolt together construction
- Powder coated blue finish
- Top shelf has a rubber mat which prevents items from sliding around in transit
- Supplied standard with no tubs
- Fits a variety of tubs - see online for more details
- Rubber castors - 2 x fixed, 2 x swivel with brakes
- Platform Heights: 184mm + 875mm
- Many accessories available to suit - see page 25
- M1887K Pictured - which comes with 2x No. 10 Recycled Plastic Black Bins



Accessories available to suit - See page 25

Code	Details	Load Capacity (kg)	Castors (mm)	Handle Height (mm)	Overall Size LxWxH (mm)	Shelf Size (mm)	Unit Weight (kg)
M1887	2 Tier Rubber Top Trolley	300	125	1050	1095x660x1050	960x655	34
M1887K	2 Tier Rubber Top Trolley - Supplied with 2 x No 10 Black Tubs						

## Steel Trolleys featuring Accessories



**M1887** - 2 Tier Rubber Top Trolley with **M1843** and 2 x No. 10 Bins



**M1884** - 3 Tier Multi-Tub Trolley with V-Cart Baskets



**M1883** - 3 Tier Steel Tub Trolley with 4 x No.10 Stack & Nest Crates



**M1880** - 2 Tier Trolley with **M1841**



# Accessories to suit Steel Trolleys

- Range of accessories to suit trolleys on pages 20-24



M1840 - Drink Holder



M1841 - Clipboard Holder



M1842 - Laptop & RF Scanner Holder



M1843 - Mesh Basket Accessory Tray



M1844 - Accessory Shelf



M1848 - A4 Pocket

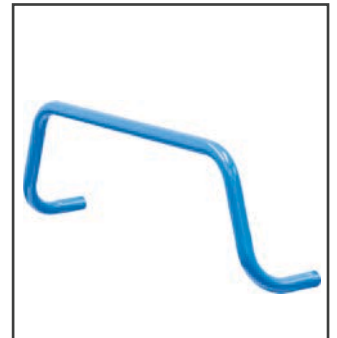

M1868 - Extra Handle



M1849 - Scanner Holder



M1845 - Flat Free Wheel Kit



M1846 - Floor Lock Brake

Code	Details
M1840	Drink Holder
M1841	Clipboard Holder
M1842	Laptop & RF Scanner Holder
M1843	Mesh Basket Accessory Tray
M1844	Accessory Shelf
M1848	A4 Pocket
M1868	Extra Handle
M1849	Scanner Holder
M1845	Flat Free Wheel Kit (includes 2 swivel wheels with brakes and 2 fixed wheels)
M1846	Floor Lock Brake



### 3 Sided Mesh Cage Trolley

- Simple bolt together construction
- Powder coated blue finish
- Rubber castors - 2 x fixed, 2 x swivel with brakes
- Many accessories available to suit - see page 29
- Mesh Size: 50x50mm

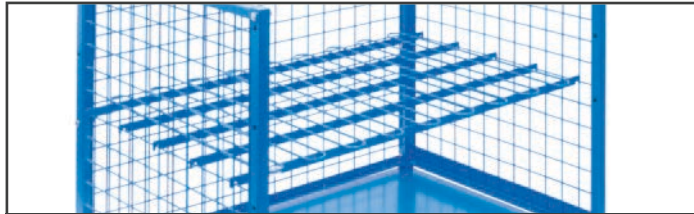

Extra shelf available to create 2 tier trolley - See page 29

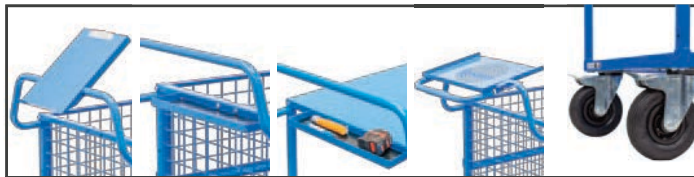

Accessories available to suit - See page 29



Code	Load Capacity (kg)	Castors (mm)	Handle Height (mm)	Overall Size LxWxH (mm)	Internal Size LXWxH (mm)	Base Height (mm)	Unit Weight (kg)
M1888	300	125	1050	1095x660x1050	910x630x690	184	35

### Mesh Cage Trolley with Drop Down Gate

- Simple bolt together construction
- Powder coated blue finish
- Rubber castors - 2 x fixed, 2 x swivel with brakes
- Drop down half gate is removable
- Many accessories available to suit - see page 27
- Mesh Size: 50x50mm



Drop down half gate for access to contents



Accessories available to suit - See page 29



Code	Load Capacity (kg)	Castors (mm)	Handle Height (mm)	Overall Size LxWxH (mm)	Internal Size LXWxH (mm)	Base Height (mm)	Unit Weight (kg)
M1889	300	125	1050	1095x660x1050	910x630x690	184	45



## Mesh Cage Trolley with Lockable Drop Down Gate & Lid

- Simple bolt together construction
- Powder coated blue finish
- Rubber castors - 2 x fixed, 2 x swivel with brake
- Drop down half gate is removable
- Fold back lid that can be locked if required
- Padlock not included
- Many accessories available to suit - see page 29
- Height to fold down section: 550mm
- Mesh Size: 50x50mm



Accessories available to suit - See page 29

Code	Load Capacity (kg)	Castors (mm)	Handle Height (mm)	Overall Size LxWxH (mm)	Internal Size LXWxH (mm)	Base Height (mm)	Unit Weight (kg)
M1890	300	125	1050	1095x660x1050	910x605x670	184	48

## Mesh Cage Trolley with Lockable Double Swing Door

- Simple bolt together construction
- Powder coated blue finish
- Rubber castors - 2 x fixed, 2 x swivel with brakes
- Double Swing Door (180 degree opening)
- Many accessories available to suit - see page 29
- Mesh Size: 50x50mm

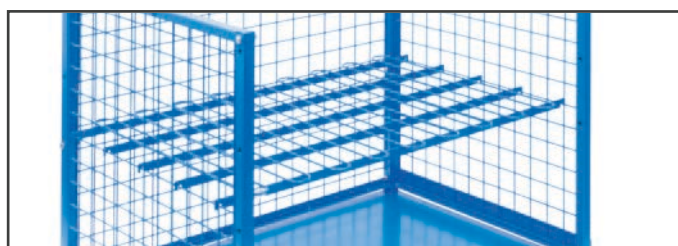

Extra shelf available to create 2 tier trolley



Accessories available to suit - See page 29

Code	Load Capacity (kg)	Castors (mm)	Handle Height (mm)	Overall Size LxWxH (mm)	Internal Size LXWxH (mm)	Base Height (mm)	Unit Weight (kg)
M1891	300	125	1050	1095x660x1050	910x605x690	184	44



## Mesh Cage Trolley with Lockable Double Swing Doors & Lid

- Simple bolt together construction
- Powder coated blue finish
- Rubber castors – 2 x fixed, 2 x swivel with brakes
- Fold back lid that can be locked if required
- Padlock not included
- Double Swing Door (180 degree opening)
- Many accessories available to suit – see page 29
- Mesh Size: 50x50mm



Code	Load Capacity (kg)	Castors (mm)	Handle Height (mm)	Overall Size LxWxH (mm)	Internal Size LXWxH (mm)	Base Height (mm)	Unit Weight (kg)
M1892	300	125	1050	1095x660x1050	910x630x690	184	50

## Mesh Cage Trolleys featuring Accessories





# Accessories to suit Mesh Trolleys

- Range of accessories to suit trolleys on pages 26-28



M1840 - Drink Holder



M1841 - Clipboard Holder



M1842 - Laptop & RF Scanner Holder



M1843 - Mesh Basket Accessory Tray



M1844 - Accessory Shelf



M1848 - A4 Pocket



M1849 - Scanner Holder

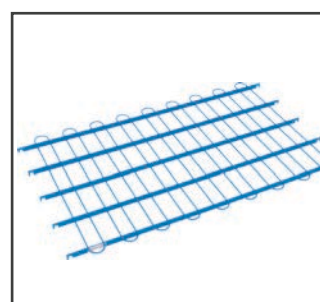

M1869 - Mesh Shelf



M1870 - Extra Handle



M1845 - Pneumatic Wheel Kit

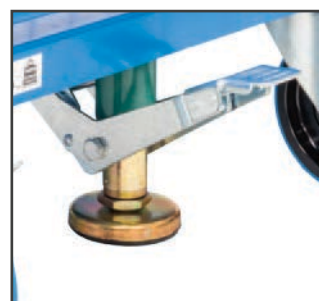

M1846 - Floor Lock Brake

Code	Details
M1840	Drink Holder
M1841	Clipboard Holder
M1842	Laptop & RF Scanner Holder
M1843	Mesh Basket Accessory Tray
M1844	Accessory Shelf
M1848	A4 Pocket
M1849	Scanner Holder
M1869	Mesh Shelf
M1868	Extra Handle
M1845	Pneumatic Wheel Kit (includes 2 swivel wheels with brakes and 2 fixed wheels)
M1846	Floor Lock Brake



## Stainless Steel Instrument Trolleys

- High grade 304 grade stainless steel
- 2 trolleys available with 2 sides and rail on 3 sides
- Rubber castors - 2 x swivel, 2 x swivel with brakes
- Front castors have locks
- Smooth welding



M1546



M1547



M1548

Code	Details	Castors (mm)	Shelf Capacity (kg)	Overall Size WxDxH (mm)	Unit Weight (kg)
M1546	Instrument Trolley (No Rails)	95	80	500x500x900	10
M1547	Instrument Trolley (No Rails)	95	80	600x500x900	11
M1548	Instrument Trolley (No Rails)	95	80	800x500x900	14

## Stainless Steel Instrument Trolleys (With Rails)

- High grade 304 grade stainless steel
- 2 trolleys available with 2 sides and rail on 3 sides
- Rubber castors - 2 x swivel, 2 x swivel with brakes
- Rails on top and bottom shelf
- Front castors have locks
- Smooth welding

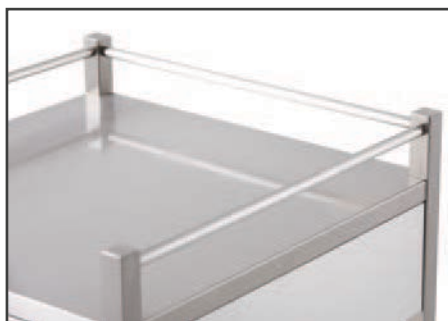

Rails on top platform to stop items falling off the back



M1530



M1535

Code	Details	Castors (mm)	Shelf Capacity (kg)	Overall Size WxDxH (mm)	Unit Weight (kg)
M1530	Single Instrument Trolley (With Rails)	95	80	500x500x900	11
M1535	Double Instrument Trolley (With Rails)	95	80	600x500x900	14





## Stainless Steel Trolleys (with Drawers)

- High grade 304 grade stainless steel
- 495mm deep drawers
- German made drawer runners which are soft closing
- Rails on top and bottom shelf
- Rubber castors - 2 x swivel, 2 x swivel with brakes
- Front Castors feature locks
- Smooth welding

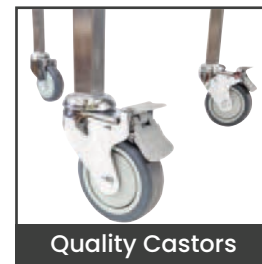

M1531



M1532



M1533



M1534

Code	Details	Castors (mm)	Drawer Capacity (kg)	Shelf Capacity (kg)	Overall Size WxDxH (mm)	Unit Weight (kg)
M1531	Single Instrument Trolley (1 Drawer)	95	25	80	500x500x900	18
M1532	Single Instrument Trolley (2 Drawer)	95	25	80	500x500x900	23
M1533	Single Instrument Trolley (3 Drawer)	95	25	80	500x500x900	30
M1534	Single Instrument Trolley (4 Drawer)	95	25	80	500x500x900	34

## Double Stainless Steel Instrument Trolleys (With Drawers)

- High grade 304 grade stainless steel
- 495mm deep drawers
- German made drawer runners which are soft closing
- Rails on top and bottom shelf
- Rubber castors - 2 x swivel, 2 x swivel with brakes
- Front Castors feature locks
- Smooth welding



M1536



M1537



M1538



M1539

Code	Details	Castors (mm)	Drawer Capacity (kg)	Shelf Capacity (kg)	Overall Size WxDxH (mm)	Unit Weight (kg)
M1536	Double Instrument Trolley (1 Drawer)	95	25	80	800x500x900	23
M1537	Double Instrument Trolley (2 Drawer)	95	25	80	800x500x900	32
M1538	Double Instrument Trolley (2 Drawer Side by Side)	95	25	80	800x500x900	26
M1539	Double Instrument Trolley (4 Drawer - 2 x Side by Side)	95	25	80	800x500x900	36



## Double Stainless Steel Instrument Trolleys (With Drawers)

- High grade 304 grade stainless steel
- 495mm deep drawers
- German made drawer runners which are soft closing
- Rails on top and bottom shelf
- Rubber castors - 2 x swivel, 2 x swivel with brakes
- Front Castors feature locks
- Smooth welding



Code	Details	Castors (mm)	Drawer Capacity (kg)	Shelf Capacity (kg)	Overall Size WxDxH (mm)	Unit Weight (kg)
M1540	Instrument Trolley (5 Drawer - 4x Half Side By Side, 1 Full)	95	25	80	800x500x970	44
M1541	Instrument Trolley (6 Drawer with 2 Shelves)	95	25	80	900x500x970	55
M1542	Instrument Trolley (6x Half Side By Side, 1 Full)	95	25	80	800x500x970	56
M1543	Instrument Trolley (4 Drawer)	95	25	80	600x500x1070	45

See online for drawer sizes

## Stainless Steel Specific Trolleys

- 304 grade stainless steel construction

### M1544 Specifications:

- Rubber castors - 2 x swivel, 2 x swivel with brakes
- Telescopic height adjustment: 850-1400mm
- Removable Tray Size: 600x400x20mm

### M1545 Specifications:

- A strong and portable oxygen bottle trolley to suit D size cylinders.
- Features a chain to secure bottle
- Rubber castors - 2 x swivel, 2 x swivel with brakes



Code	Details	Overall Size (mm)	Castors (mm)
M1544	Instrument Table / Trolley	600x400x20	65
M1545	Oxygen Trolley (with Safety Chain)	380x270x1000	95



## Stainless Steel Platform Trolleys

- Heavy duty stainless steel platform trolley which is great for use in food and medical areas.
- Fixed handle
- 304 grade stainless steel
- Rubber castors - 2 x fixed, 2 x swivel with brakes



Code	Load Capacity (kg)	Castors (mm)	Handle Height (mm)	Platform Size (mm)	Platform Height (mm)	Unit Weight (kg)
M1420	600	200	970	915x610	280	41
M1421	600	200	970	1220x610	280	46

## Stainless Steel 2 & 3 Tier Trolleys

- Heavy duty stainless steel 2 and 3 tier trolleys which are great for use in hospitality areas.
- The shelves can be used as a flat platform or turned upside down and used as a tray
- Polyurethane castors - 4 x swivel
- 304 grade stainless steel
- Overall length including handle: 750mm



Code	Details	Load Capacity (kg)	Castors (mm)	Handle Height (mm)	Distance Between Trays (mm)	Tray Size WxDxH (mm)	Platform Size (mm)	Unit Weight (kg)
M1430	2 Tier Trolley	200	100	910	670	600x400x50	655x400	14
M1435	3 Tier Trolley	200	100	910	310	600x400x50	655x400	18



## 4 Tier Stainless Steel Trolley

- The 4 tier stainless steel trolley is the perfect solution for restaurants, hospitals, hair salons, nursing homes etc.
- Grade of stainless: 201
- Polyurethane castors - 2 x swivel, 2 x swivel with brakes



Code	Load Capacity (kg)	Castors (mm)	Height to Top Shelf (mm)	Shelf Size (mm)	Distance Between Shelves (mm)	Overall Size LxWxH (mm)	Unit Weight (kg)
M1440	100	100	1125	825x500	280	910x590x1260	20

## 2 Tier Flat Deck Trolley

- Electro galvanised handle and end frame
- Chipboard shelves covered in stainless steel sheet
- Polyurethane castors - 2 x swivel, 2 x swivel with brakes
- Top Shelf Height: 720mm
- Handle Height: 950mm



Code	Load Capacity (kg)	Castors (mm)	Shelf Size (mm)	Distance Between Shelves (mm)	Overall Size LxWxH (mm)	Unit Weight (kg)
M1445	200	100	760x435	510	840x430x970	21



## 3 Tier Stainless Steel Platform Trolley

- Great for use in medical areas, food preparation, schools, laundries etc where hygiene is important
- Rubber corner protectors as standard
- Middle shelf can be removed to make a 2 tier trolley
- Rubber castors - 2 x swivel, 2 x swivel with brakes
- Castors: 100mm



Code	Load Capacity (kg)	Handle Height (mm)	Shelf Size (mm)	Shelf Heights (mm)	Overall Size LxWxH (mm)	Unit Weight (kg)
M1436	150	890	850x450	200 + 510 + 820	850x450x890	12

## Heavy Duty Fully Welded Stainless Steel Tier Trolley

- Heavy duty stainless steel 2 tier trolleys are ideal for food and medical areas
- Ergonomic handles at both ends
- Optional PVC buffers available
- 304 grade stainless steel
- Rubber castors - 2 x swivel, 2 x swivel with brakes



Code	Details	Load Capacity (kg)	Castors (mm)	Handle Height (mm)	Shelf Size (mm)	Shelf Heights (mm)	Overall Size LxWxH (mm)	Unit Weight (kg)
M1431	2 Tier Trolley	300	125	1095	880x480	325 + 855	1120x540x1095	18
M1433	PVC Buffer Kit (includes 4 buffers)							



## Furniture Mover Set

- Great for moving heavy furniture and equipment
- Winch handle geared mechanism
- Non marking castors
- Sold as a set of 2 only
- Ratchet straps are included



Code	Load Capacity (kg)	Castors (mm)	Lifting Height (mm)	Lifting Plate Size (mm)	Overall Size LxWxH (mm)	Unit Weight per Set of 2 (kg)
M1225	600	150	300	120x225	570x390x825	34



M1219

## Flat Equipment Moving Dollies

- Great for moving furniture and equipment due to their low height and high capacity
- Both models come with 4 heavy duty swivel castors
- **M1219** is made from polypropylene with steel tubing. Rubber moulds on each end to protect items from scatching and marking. Supplied with nylon castors
- **M1220** has a non slip vinyl platform with a PVC bumper strip around the edge.
- Supplied with polyurethane castors.



M1220

Code	Details	Load Capacity (kg)	Castors (mm)	Overall Size LxWxH (mm)	Unit Weight (kg)
M1219	Flat Equipment Moving Dolly	350	75	765x460x130	6
M1220	Flat Platform Steel Dolly	370	125	920x620x180	15



See page 84



See page 122



See page 134



## Self Levelling Shelf Trolley

- This trolley has an innovative design in which the top platform automatically adjusts to maintain a safe working height as weight is added or taken off.
- Makes work operations faster, safer and more efficient by reducing manual exertion and bending.
- Ideal for use in supermarkets, liquor and hardware stores
- At 90kg, the platform is at the lowest position.
- Trolleys are nestable for compact storage
- Electro galvanised finish
- Rubber castors - 2 x swivel, 2 x swivel with brake



Code	Load Capacity (kg)	Castors (mm)	Handle Height (mm)	Height to Top Shelf (mm)	Distance Between Shelves (mm)	Overall Size LxWxH (mm)	Unit Weight (kg)
M1690	300	125	995	810	610	960x525x1030	36

## Nestable Basket Trolley

- The Nestable Basket Trolley is ideal for use in supermarkets, liquor and hardware stores
- Top basket can be folded upwards so that multiple trolleys can be nested together when not in use
- Electro galvanised finish
- Rubber castors - 2 x swivel, 2 x swivel with brake



Code	Load Capacity (kg)	Top Shelf Capacity (kg)	Castors (mm)	Handle Height (mm)	Distance Between shelves (mm)	Overall Size LxWxH (mm)	Unit Weight (kg)
M1691	300	100	125	1010	430	870x530x1010	21



# Section 1 Trolleys & Hand Trucks



**FREECALL 1800 750 900**  
[www.mhaproducts.com.au](http://www.mhaproducts.com.au)





# Auto Levelling Trolley

- The Auto Levelling Trolley is designed to dramatically reduce back injuries and strain as the load automatically increases in height as items are lifted off and lowers as items are loaded.
- The top shelf is self levelling at 0-250kg
- At 200kg the top shelf will be at the lowest position which is 290mm above the bottom shelf allowing for empty crates to be stored underneath
- Bottom Platform Height: 200mm
- Top Platform Height: 890mm (highest position)
- Top Platform Height: 485mm (lowest position)
- Type of castors - 4 swivel 2 with brake
- 4 x elastic rubber castor swivel castors diameter 125mm and 2 fixed centre wheels which allow forturning within its own length.
- Spring operated press foot floor brake



Watch a video of this in operation on our website here, [www.mhaproducts.com.au/LT2047](http://www.mhaproducts.com.au/LT2047)



Code	Load Capacity (kg)	Top Shelf Capacity (kg)	Castors (mm)	Handle Height (mm)	Internal Platform Size LxW (mm)	Overall Size LxWxH (mm)	Unit Weight (kg)
LT2047	400	200	125	995	1200x585	1525x675x1052	89



See page 129



See page 184



See page 251

## Prestige 2 & 3 Tier Trolleys

Heavy duty steel trolleys which are great for dozens of uses in warehouses, schools, hospitals etc.

- Powder coated steel construction
- Chrome steel handle with plastic end caps
- The shelves can be used as a flat platform or turned upside down and used as a tray
- Polyurethane castors - 2 x fixed, 2 x swivel



M1071



Shelf levels are adjustable

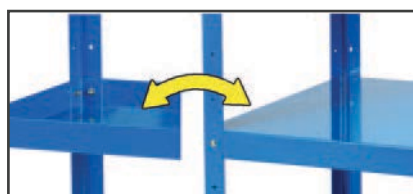

Reversible shelves



M1070

Code	Details	Load Capacity (kg)	Castors (mm)	Handle Height (mm)	Shelf Size (mm)	Overall Size LxWxH (mm)	Unit Weight (kg)
M1070	2 Tier Trolley	250	100	890	750x500	820x500x915	18
M1071	3 Tier Trolley	250	100	890	750x500	820x500x915	22



## Timber Deck Wagon Platform Truck

- Swivel handled platform truck for moving and turning easily
- The platform is reinforced with steel cross bars for extra strength
- Heavy duty timber platform
- Powder coated blue
- Rubber castors – 2 x fixed, 2 x swivel



Code	Load Capacity (kg)	Castors (mm)	Handle Height (mm)	Platform Size (mm)	Overall Size LxWxH (mm)	Unit Weight (kg)
M1060	700	250	1100	1200x700	1200x700x1100	60

## Wagon Platform Truck (With Sides)

- Swivel handled platform truck for moving and turning easily
- Timber floor and side panels
- The platform is reinforced with steel cross bars for extra strength
- Powder coated blue
- Side Panel Height: 610mm
- Rubber castors – 2 x fixed, 2 x swivel



Code	Load Capacity (kg)	Castors (mm)	Handle Height (mm)	Platform Height (mm)	Platform Size (mm)	Overall Size LxWxH (mm)	Unit Weight (kg)
M1061	700	250	1100	410	1200x700	1440x700x1100	76

## All Terrain Platform Trolley

- The All Terrain Platform Trolley is perfect for construction sites and general warehouse use
- Heavy duty trolley construction
- Handle activated brake
- Swivel handle for steering the trolley
- Powder coated frame with plywood deck
- Optional sides available
- 4 x pneumatic wheels with steel rim



Code	Details	Load Capacity (kg)	Castors (mm)	Overall Size LxWxH (mm)	Unit Weight (kg)
M1063	All Terrain Platform Trolley	1300	300	1200x690x397	49
M1064	Optional Sides to suit All Terrain Platform Trolley (300mm high)				



## Basket Picking Trolley

- The Basket Picking Trolley is lightweight making it ideal for use in clothing stores, mail rooms & order picking in warehouses
- Two mesh baskets allow various sized items to be moved
- Electro galvanised finish
- Rubber castors - 2 x swivel, 2 x swivel with brake



Code	Load Capacity (kg)	Castors (mm)	Distance Between Baskets (mm)	Size of Lower Basket LxWxH (mm)	Size of Top Basket LxWxH (mm)	Overall Size LxWxH (mm)	Unit Weight (kg)
M1677	100	100	300	605x400x110	605x400x360	690x410x950	13

## Ezi Mover Trolley

- The Ezi Mover trolley is great for both indoor or outdoor use
- Black powder coated frame which fits 3 bin sizes
- Trolley shown with bin which is sold separately (see page 115 for bins)
- Rear pneumatic wheel and rubber front castor



Code	Load Capacity (kg)	Front Castor (mm)	Rear Wheels (mm)	Height to top lip (mm)	Overall Size LxWxH (mm)	Unit Weight (kg)
M1615	70	125	230	730	1040x570x860	10

## Service Cart With Side Rails

- Ideal cart for use in environments such as restaurants, hospitals, libraries, retail stores, schools etc.
- Lightweight trolley yet very robust design
- Electro galvanised finish
- Rubber castors - 2 x swivel, 2 x swivel with brake



Code	Load Capacity (kg)	Castors (mm)	Distance Between Shelves (mm)	Height to Top Shelf (mm)	Tray Size LxWxH (mm)	Overall Size LxWxH (mm)	Unit Weight (kg)
M1037	250	125	325	705	935x535x90	1130x550x940	24



## Mesh Trolley with Folding Lid

- The Mesh Trolley with Folding Lid is the perfect solution for hospitals, laundries and nursing homes etc
- Lockable lid ensures that goods can be stored securely in high traffic areas
- White powder coated finish
- Polyurethane castors - 4 x swivel



Code	Load Capacity (kg)	Castors (mm)	Basket Size LxWxH (mm)	Overall Size LxWxH (mm)	Unit Weight (kg)
M1680	100	100	770x570x430	800x600x915	18

## Plastic X Shape Laundry Cart

- Lightweight trolley which is great for carting linen or waste
- Easily remove the waste bag by unhooking from the frame
- Can be folded when not in use
- Strong vinyl bag
- Rubber castors - 4 x swivel



Bag can easily be removed from the frame



Code	Details	Load Capacity (kg)	Volume (L)	Castors (mm)	Folded Size LxWxH (mm)	Overall Size LxWxH (mm)	Unit Weight (kg)
M9070	Laundry Cart	60	178	75	660x440x1100	690x660x950	10
M9071	Replacement Bag to suit Plastic X Shape Laundry Cart						



## X Shape Laundry Cart (150L)

- Lightweight trolley which is great for carting linen or waste
- Can be folded when not in use
- Strong vinyl bag
- Rubber castors - 4 x swivel



Bag is looped over handles and secured with clips



Code	Code	Load Capacity (kg)	Volume (L)	Castors (mm)	Overall Size LxWxH (mm)	Unit Weight (kg)
M9060	Laundry Cart	100	150	100	620x620x995	10
M9061	Replacement Bag to suit X Shape Laundry Cart					



## Service Cart

- Great for storing small parts and items neatly in the office
- Supplied with plastic tubs as pictured
- Plastic tubs are made from recycled plastic and are not suitable for food applications
- Integrated frame handles
- Rubber castors - 2 x swivel, 2 x swivel with brakes

3 removable nesting plastic tubs included



Code	Load Capacity (kg)	Castors (mm)	Handle Height (mm)	Plastic Tub Size LxWxH (mm)	Overall Size LxWxH (mm)	Unit Weight (kg)
M6970	15	75	990	530x390x150	600x400x990	11

## 3 Basket Office Trolley

- Great for storing small parts and items neatly in the office
- Supplied with plastic baskets as pictured
- Integrated frame handles
- Plastic Basket Size (LxWxH): 510x360x200mm
- Nylon castors - 2 x swivel, 2 x swivel with brakes



3 removable nesting baskets included



Code	Load Capacity (kg)	Castors (mm)	Shelf Size (mm)	Overall Size LxWxH (mm)	Unit Weight (kg)
M1525	50	100	500x400	520x470x1085	11



## 2 Tier Trolley (With Adjustable Shelves)

- This 2 tier trolley is ideal for stock picking in warehouses and retail applications.
- Optional ladder and clipboard.
- Ladder can be folded up for compact storage when not in use.
- Electro galvanised finish with laminate shelves
- Shelf Size: 1000x425mm
- Rubber castors - 2 x swivel, 2 x swivel with brakes



Ergonomic Handle



Optional Ladder



Optional Clipboard

Code	Details	Load Capacity (kg)	Castors (mm)	Overall Size LxWxH (mm)	Unit Weight (kg)
M1670	2 Tier Trolley (with adjustable shelves)	250	125	1195x470x1120	26
M1672	Optional Ladder with Handles	125	-	550x450x670	9
M1673	Optional Clipboard Unit				

## 3 Tier Trolley (With Adjustable Shelves)

- This 3 tier trolley is ideal for stock picking in warehouses and retail applications.
- Middle shelf is height adjustable
- Optional ladder can be folded up for compact storage when not in use.
- Electro galvanised finish with laminate shelves
- Shelf Size: 1000x425mm
- Rubber castors - 2 x swivel, 2 x swivel with brakes



Optional Clipboard Available



Optional Ladder Available

Code	Details	Load Capacity (kg)	Castors (mm)	Overall Size LxWxH (mm)	Unit Weight (kg)
M1671	3 Tier Trolley (with adjustable shelves)	250	125	1195x470x1120	32
M1672	Optional Ladder with Handles	125	-	550x450x670	9
M1673	Optional Clipboard Unit				



# Retail Stock Trolley

- The Retail Stock Trolley is ideal for retail applications to move stock between back of house and front of house
- This trolley is also suitable for transferring goods of any type throughout super markets, factories, and any workplace
- Centre wheel kit for turning in tight spaces
- Basket for storage of small items
- Electro galvanised and clear coated
- Rubber castors - 2 x fixed, 4 x swivel



Optional clipboard available



Code	Details	Load Capacity (kg)	Castors (mm)	Height to Top Shelf (mm)	Distance Between Shelves (mm)	Overall Size LxWxH (mm)	Unit Weight (kg)
M1685	Stock Trolley	400	125	715	475	1320x430x1120	24
M1673	Optional Clipboard Unit						

# 3 Tier Utility Service Cart

- Heavy duty plastic construction which resists dents, chips and rust.
- Supplied standard with 2 removable buckets
- Small bucket size (LxWxH): 360x290x360mm
- Large bucket size (LxWxH): 360x290x560mm
- Polyurethane castors - 2 x fixed, 2 x swivel with brakes
- Top Shelf Size (Internal): 450x740mm



Code	Load Capacity (kg)	Castors (mm)	Overall Size LxWxH (mm)	Unit Weight (kg)
M7100	250	100	1395x520x975	19





## 2 Tier Utility Service Carts

- Heavy duty plastic construction which resists dents, chips and rust
- Polypropylene handles with aluminium frames
- Sturdy and stable but lightweight making it easy to manoeuvre
- Rubber castors - 2 x swivel, 2 x swivel with brakes



Code	Load Capacity (kg)	Castors (mm)	Shelf Size (mm)	Overall Size LxWxH (mm)	Unit Weight (kg)
M1480	250	100	680x450	870x500x950	9



## Large 2 Tier Utility Cart

- Heavy duty plastic construction which resists dents, chips and rust
- Polypropylene handles with aluminium frames
- Sturdy and stable but lightweight making it easy for manoeuvrability
- Rubber Castors - 2 x fixed, 2 x swivel with brakes

Code	Load Capacity (kg)	Castors (mm)	Shelf Size (mm)	Overall Size LxWxH (mm)	Unit Weight (kg)
M1481	250	100	915x520	1100x500x950	13

## 2 Tier Utility Cart (With Sides)

- Heavy duty plastic construction which resists dents, chips and rust
- Polypropylene handles with aluminium frames
- Sturdy and stable but lightweight making it easy to manoeuvre
- These utility carts have the added benefit of polypropylene side panels
- Rubber castors - 2 x swivel, 2 x swivel with brakes



Code	Details	Load Capacity (kg)	Castors (mm)	Shelf Size (mm)	Overall Size LxWxH (mm)	Unit Weight (kg)
M1482	Large 2 Tier Utility Cart	250	100	680x450	850x480x950	11
M1483	Drawer Unit with Lock to suit M1482					



### 3 Tier Utility Carts

- Heavy duty plastic construction which resists dents, chips and rust
- Polypropylene handles with aluminium frames
- Sturdy and stable but lightweight making it easy to manoeuvre
- Rubber castors - 2 x swivel, 2 x swivel with brakes



M1451



M1452

Code	Details	Load Capacity (kg)	Castors (mm)	Shelf Size (mm)	Overall Size LxWxH (mm)	Unit Weight (kg)
M1451	3 Tier Utility Service Trolley (Narrow)	180	75	485x365	660x380x900	6
M1452	3 Tier Utility Service Trolley	180	100	615x450	810x500x970	10



M1455



M1456

### Utility Carts (With Side Panels)

- These utility carts have the same specifications as the other 3 tier utility carts with the added benefit of polypropylene side panels
- Rubber castors - 2 x swivel, 2 x swivel with brakes

Code	Details	Load Capacity (kg)	Castors (mm)	Shelf Size (mm)	Overall Size LxWxH (mm)	Unit Weight (kg)
M1455	3 Tier Utility Trolley (with sides)	250	100	680x450	870x500x1010	15
M1456	Extra Long 3 Tier Service Trolley (with sides)	250	100	920x520	1110x520x1010	21

### 3 Tier Service Cart

- Heavy duty plastic construction which resists dents, chips and rust
- Polypropylene handles with aluminium frames
- Sturdy and stable but lightweight making it easy to manoeuvre
- Lockable front doors
- Rubber castors - 2 x swivel, 2 x swivel with brakes



Code	Load Capacity (kg)	Castors (mm)	Shelf Size (mm)	Overall Size LxWxH (mm)	Unit Weight (kg)
M1461	250	100	680x450	870x500x1010	17



## 2 Tier Plastic Utility Cart (with Ergonomic Handle)

- Heavy duty plastic construction
- Built in storage bin in the handle which is great for storing small parts or tools
- Ergonomic handle design
- Round corners which avoid marking of walls and furniture from sharp edges
- Rubber castors - 2 x fixed, 2 x swivel

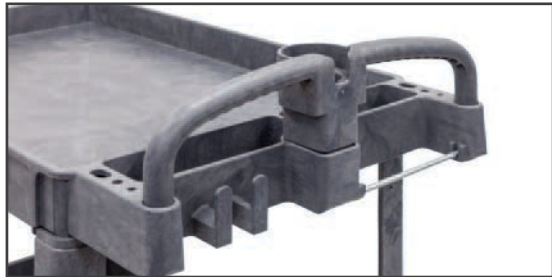

Code	Load Capacity (kg)	Castors (mm)	Platform Heights (mm)	Tray Size LxWxH (mm)	Overall Size LxWxH (mm)	Unit Weight (kg)
M1415	250	125	150 + 850	920x625x70	1110x650x990	22.4

## 3 Tier Plastic Utility Cart (with Ergonomic Handle)

- Heavy duty plastic construction
- Built in storage bin in the handle which is great for storing small parts or tools
- Ergonomic handle design
- Round corners which avoid marking of walls and furniture from sharp edges
- Distance between shelves with middle shelf is 200mm
- Rubber castors - 2 x fixed, 2 x swivel



Code	Load Capacity (kg)	Castors (mm)	Platform Heights (mm)	Tray Size LxWxH (mm)	Overall Size LxWxH (mm)	Unit Weight (kg)
M1417	250	125	150, 475 & 850	920x625x70	1110x650x990	25.4



## 3 Tier Utility Cart

- Versatile functional carts for food service, catering etc
- Lightweight, strong, reinforced polymer construction with aluminium posts
- Rubber castors - 4 x swivel
- Spacing between shelves: 340mm



Code	Load Capacity (kg)	Castors (mm)	Handle Height (mm)	Shelf Size (mm)	Overall Size LxWxH (mm)	Unit Weight (kg)
M1450	150	75	910	600x430	845x430x910	10

## Quad Deck Tool Cart (With Tool Board)

- Excellent tool cart with square hole pegboard
- Supplied with accessories
- Tray depth: 50mm
- Nylon castors - 2 x swivel, 2 x swivel with brakes
- Shelf Size: 585x405mm



Code	Castors (mm)	Load Capacity (kg)	Overall Size LxWxH (mm)	Shelf Heights (mm)	Unit Weight (kg)
M1466	100	300	680x430x1215	170 + 370 + 570 + 770	24



## 2 Tier Tool Trolley (With Drawers)

- Twin drawers with ball bearing sliders and quick return system
- Top drawer depth: 60mm
- Bottom drawer depth: 80mm
- Rubber castors - 2 x swivel, 2 x swivel with brakes



Code	Load Capacity (kg)	Castors (mm)	Shelf Size (mm)	Overall Size LxWxH (mm)	Unit Weight (kg)
M1485	250	100	680x450	870x500x950	20



## Triple Deck Tool Cart (With Tool Board & Drawer)

- Single drawer with ball bearing sliders and quick return system
- Hooks sold separately
- Side can holder and tray supplied
- Drawer depth: 80mm
- Rubber castors - 2 x swivel, 2 x swivel with brakes

Code	Load Capacity (kg)	Castors (mm)	Shelf Size (mm)	Overall Size LxWxH (mm)	Unit Weight (kg)
M1465	250	100	680x450	900x500x1430	25

## 3 Tier Tool Trolley (With Drawer)

- Single drawer with ball bearing sliders and quick return system
- Drawer depth: 80mm
- Rubber castors - 2 x swivel, 2 x swivel with brakes



Code	Load Capacity (kg)	Castors (mm)	Shelf Size (mm)	Overall Size LxWxH (mm)	Unit Weight (kg)
M1460	250	100	680x450	780x500x1010	15



## 3 Tier Aluminium Framed Computer Cart (With Slide Out Shelf)

- These computer carts are great for both office and warehouse use
- Rubber castors - 2 x swivel, 2 x swivel with brakes



Code	Load Capacity (kg)	Castors (mm)	Overall Size LxWxH (mm)	Unit Weight (kg)
M1470	250	100	810x510x1160	18



## 3 Tier Steel Computer Cart

- These computer carts are great for both office and warehouse use
- Rubber castors - 2 x swivel, 2 x swivel with brakes



Code	Load Capacity (kg)	Castors (mm)	Overall Size LxWxH (mm)	Unit Weight (kg)
M1472	250	100	610x520x910	28

## Steel Utility Cart (3 Drawers + 3 Shelves)

- Strong steel construction - great for a general parts and tool storage trolley
- Comes complete with 3 drawers and 3 shelves
- Drawers and middle shelf can be removed if not required
- Shelf Depth: 50mm
- Poly castors - 2 x fixed, 2 x swivel with brakes



Code	Load Capacity (kg)	Castors (mm)	Shelf Capacity (kg)	Shelf Size (mm)	Overall Size LxWxH (mm)	Unit Weight (kg)
M1405	150	125	50	715x410	830x420x870	23



## Order Picking Trolleys

- Single and double order picking trolleys
- Heavy duty warehouse order picking trolley which is ideal for order picking and other applications
- Simple bolt together construction
- Powder coated finish
- Rubber castors - 2 x swivel, 2 x swivel with brakes
- Handle Height: 1050mm
- Top Rail Height: 1000mm
- Bottom Shelf Height: 230mm
- Range of accessories available to suit
- Single Tub Trolley (M1610) fits 1 tub
- Double Tub Trolley (M1611) fits 2 tubs
- Trolleys fit either No.7, No. 10 and No.15. Plastic tubs are sold separately which are available in 6 colours (black, blue, green, red, white and yellow)



Tubs that suit order picking trolleys



Single Order Picking Trolley



Double Tub Order Picking Trolley



M1610K pictured with M1842 Laptop Holder & M1843 Mesh Basket Accessory Tray



M1611K pictured with M1841 Clipboard Holder & M1843 Mesh Basket

Code	Details	Load Capacity (kg)	Castors (mm)	Overall Size LxWxH (mm)	Unit Weight (kg)
M1610	Single Order Picking Trolley	250	125	835x425x1050	15
M1610K	Single Order Picking Trolley Kit*	250	125	835x425x1050	17
M1611	Double Tub Order Picking Trolley	250	125	1010x650x1050	21
M1611K	Double Tub Order Picking Trolley Kit**	250	125	1010x650x1050	23

\* Kit supplied with 1x No. 10 Red Plastic Tub

\*\* Kit supplied with 1x No. 10 Red Plastic Tubs



## Twin Offset Tub Order Picking Trolley

- Heavy duty warehouse order picking trolley which is ideal for order picking and other warehouse applications
- Simple bolt together construction
- Powder coated finish
- Rubber castors - 2 x swivel, 2 x swivel with brakes
- Range of accessories available to suit
- Fits 2 tubs in either No.7, No.10 and No.15. Plastic tubs are sold separately which are available in 6 colours (black, blue, green, red, white and yellow)



Code	Details	Load Capacity (kg)	Castors (mm)	Overall Size LxWxH (mm)	Unit Weight (kg)
M1612	Twin Offset Tub Trolley	250	125	835x425x1050	15
M1612K	Twin Offset Tub Trolley Kit*	250	125	835x425x1050	17

\* Kit supplied with 2x No. 10 Red Plastic Tubs

## Accessories to suit Order Picking Trolleys



Drink Bottle Holder



Clipboard Holder



Laptop & RF Holder



Mesh Basket



Accessory Shelf



A4 Pocket



Scanner Holder

Code	Details
M1840	Drink / Water Bottle Holder
M1841	Clipboard Holder
M1842	Laptop & RF Holder
M1843	Mesh Basket
M1844	Accessory Shelf
M1848	A4 Pocket
M1849	Scanner Holder





## Multi-Purpose Cage Trolleys

- Industrial quality trolleys with cage stop goods falling off the platform
- The cage has fold down sides for easy loading and unloading
- Powder coated steel construction with vinyl platform
- Surround bumper on perimeter of trolley
- Ergonomically designed with handle at optimum height
- Polyurethane castors - 2 x fixed, 2 x swivel

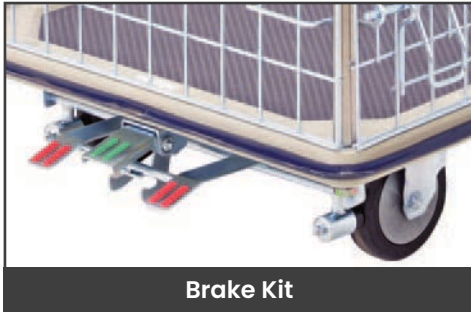

Brake Kit



Clipboard Holder

Code	Details	Load Capacity (kg)	Castors (mm)	Handle Height (mm)	Platform Size (mm)	Platform Height (mm)	Overall Size LxWxH (mm)	Unit Weight (kg)
M1030	Cage Trolley	220	100	1000	750x490	140	820x490x1000	19
M1031	Cage Trolley	370	125	1000	880x580	190	1000x620x1000	27
M1005	Brake Kit to suit M1031							
M1673	Clipboard Holder Attachment to suit M1030 & M1031							

## Extra Large Prestige Platform Trolley (With Cage)

- Wire cage has fold down sides to make loading and unloading easier
- Powder coated steel construction with vinyl decks
- Surround bumper on perimeter of trolley
- Cage Height: 770mm
- Polyurethane castors - 2 x fixed, 2 x swivel
- Optional flat free wheel kit available includes 2 swivel wheels with brakes and 2 fixed wheels
- Platform height with pneumatic wheels: 310mm



Flat Free Wheel Kit

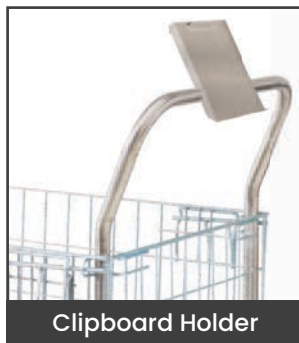

Clipboard Holder

Code	Details	Load Capacity (kg)	Castors (mm)	Handle Height (mm)	Platform Size (mm)	Platform Height (mm)	Overall Size LxWxH (mm)	Unit Weight (kg)
M1032	Platform Trolley	500	200	1000	1170x770	240	1270x770x1000	47
M1845	Flat Free Wheel Kit - Includes 2 Swivel Wheels with Brakes and 2 Fixed Wheels							
M1673	Clipboard Holder Attachment to suit M1032							



## Multi-Purpose 2 Tier Cage Trolleys

- General purpose 2 tier trolleys with wire sides which keep items on platform
- Powder coated steel construction with vinyl decks
- Surround bumper on perimeter of trolley
- Ergonomically designed with handle at optimum height
- Cage can be removed if not required
- Polyurethane castors - 2 x fixed, 2 x swivel



Brake Kit



Clipboard Holder



Code	Details	Load Capacity (kg)	Castors (mm)	Handle Height (mm)	Platform Size (mm)	Platform Height (mm)	Overall Size LxWxH (mm)	Unit Weight (kg)
M1035	2 Tier Trolley	220	100	1010	740x480	140 + 660	790x480x1010	23
M1036	2 Tier Trolley	370	125	1000	920x620	180 + 650	960x620x1000	33
M1005	Brake Kit to suit M1036							
M1673	Clipboard Holder Attachment to suit M1035 & M1036							

## 3 Tier Convertible Cage Trolley

- General purpose 3 tier trolley which can be converted into a platform trolley with sides as pictured
- Rubber castors - 2 x fixed, 2 x swivel with brakes

Image shown with top and middle shelves removed and inserted as sides to convert into a cage trolley



Code	Load Capacity (kg)	Castors (mm)	Handle Height (mm)	Shelf Heights (mm)	Shelf Size (mm)	Overall Size LxWxH (mm)	Unit Weight (kg)
M1085	200	125	1160	190 + 600 + 980	900x600	950x610x1160	45



## Mesh Trolley with Folding Lid & Side

- The Mesh Trolley is able to hold items safely and securely due to the attached lid.
- Foldable side and lid for easy access to products
- Comes with a padlock hook which allows the trolley to be securely locked when not in use
- Mesh Size: 50x50mm
- Electro galvanised finish
- Polyurethane castors - 2 x swivel, 2 x swivel with brakes



Code	Load Capacity (kg)	Castors (mm)	Overall Size LxWxH (mm)	Unit Weight (kg)
M1682	150	100	1180x662x858	28

## Mesh Trolley

- The Mesh Trolley is suitable for holding and storing a large variety of items
- This trolley is ideal for use in warehouses, hospitals, schools and sporting events etc
- Optional lid for storing items securely
- Electro galvanised finish
- Polyurethane castors - 2 x swivel, 2 x swivel with brakes

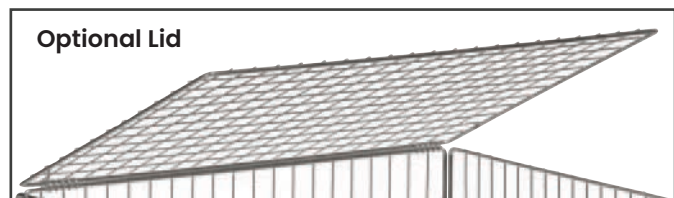

Code	Details	Load Capacity (kg)	Castors (mm)	Overall Size LxWxH (mm)	Unit Weight (kg)
M1683	Mesh Trolley	100	125	830x630x735	18
M1684	Optional Lid for Mesh Trolley				2



## Parcel Trolley with Removable Sides

- This Parcel Trolley is ideal for stock picking and moving boxed products.
- Removable sides for ease of access to platform.
- Adjustable handle height
- Electro galvanised finish with white laminate base
- Rubber castors - 2 x fixed, 2 x swivel with brakes
- Castors: 160mm



Clipboard Holder



Flat Free Wheel Kit



Code	Details	Load Capacity (kg)	Overall Size LxWxH (mm)	Unit Weight (kg)
M1675	Parcel Trolley	300	1190x650x1025	36
M1845	Flat Free Wheel Kit - 2 Swivel Wheels with Brakes & 2 Fixed Wheels			
M1673	Clipboard Holder Attachment to suit M1675			

## Scooter Stock Picker

- The Scooter Stock Picker is the ideal product for moving stock in large warehouses
- Comes standard with single base shelf
- Optional extra shelf, clipboard writing panel and cage basket available to suit
- Rubberized handles for ergonomic grip.
- Base plate with Antislip surface.
- Bell on handle to alert people
- Rubber surround on base shelf
- Rubber wheels - Rear wheel has brake



M1673



M1721



Pictured with cage basket (M1723)

Code	Details	Capacity (kg)	Wheels (mm)	Overall Size LxWxH (mm)	Unit Weight (kg)
M1720	Scooter Stock Picker	200	200	1470x70x1020	42
M1721	Optional Shelf (used to make a 2nd tier)			520x610 (LxW)	8
M1673	Optional Clipboard Writing Panel			340x248 (LxW)	2
M1723	Optional Cage Basket			541x645x535	7



## Nesting Roll Cage Trolley

- Nestable A-frame Roll Cage Trolley
- Shelves and sides fold for nesting to increase space efficiency
- Single full size lockable swing door
- Folding shelf for maximum space efficiency
- Finish: Zinc
- Nylon Castors - 2 x swivel with brakes, 2 x fixed
- Shelf Capacity: 125kg
- Shelf Size (WxD): 665x760mm
- Distance between shelves: approx: 700mm



Trolleys nest together for space saving



Watch a video of this in operation on our website here, [www.mhaproducts.com.au/M1760](http://www.mhaproducts.com.au/M1760)



Code	Load Capacity (kg)	Castors (mm)	Shelf Heights (mm)	Overall Size WxDxH (mm)
M1760	250	125	245 + 970	750x850x1750

## 2 Sided Roll Cage Trolley

- Ideal for use in retail, e-commerce and warehouse applications.
- This trolley has an open front for easy access to contents inside.
- Optional shelf available (M1762)
- Z base for perfect nesting
- Finish: Zinc
- Nylon castors - 2x fixed, 2x swivel with brakes
- Internal Dimensions (WxDxH): 845x695x1635mm
- Lower level height: 210mm
- Shelf Capacity: 125kg
- Shelf Size: 770x695mm



Pictured with 2 extra shelves



Watch a video of this in operation on our website here, [www.mhaproducts.com.au/M1761](http://www.mhaproducts.com.au/M1761)



Code	Details	Load Capacity (kg)	Castors (mm)	Overall Size WxDxH (mm)	Unit Weight (kg)
M1761	2 Sided Roll Cage Trolley	500	125	845x760x1855	44
M1762	Removable Shelf to suit 2 Sided Roll Cage Trolley				4



# 4 Sided Roll Cage Trolley

- Ideal for use in retail, e-commerce and warehouse applications.
- This trolley has doors to keep contents secure, making it ideal for front of house.
- Rear of Trolley has 2 half doors
- Front of Trolley has 1 full height door
- Middle shelf is foldable
- Z base for perfect nesting
- Trolleys are Nestable to increase space efficiency
- Finish: Zinc
- Nylon castors - 2x fixed, 2x swivel with brakes
- Internal Dimensions (WxDxH): 770x695x1635mm
- Lower level height: 210mm
- Shelf Height: 1140mm
- Shelf Size: 770x695mm



Watch a video of this in operation here: [www.mhaproducts.com.au/M1763](http://www.mhaproducts.com.au/M1763)



Code	Load Capacity (kg)	Castors (mm)	Overall Size WxDxH (mm)	Unit Weight (kg)
M1763	500	125	845x760x1855	56

## ROLL CAGE TROLLEYS



## Heavy Duty Goods Trolley

- This goods trolley is able to be completely folded when not in use
- Multi-purpose trolley with lockable gates is ideal for transporting goods safely and securely
- Powder coated finish
- Rubber castors - 2 x swivel, 2 x swivel with brakes
- Castors: 125mm
- Optional flat free wheel kit available - 2 x fixed wheels and 2 x swivel wheels with brakes
- Load Capacity: 500kg
- Internal Size (LxWxH): 1030x720x750mm
- Overall Size (LxWxH): 1085x795x990mm
- Unit Weight: 75kg



Fold out doors for easy access to items inside



Has a small footprint when folded for compact storage when not in use



**Flat Free Wheel Kit**  
(Includes 2 Swivel Wheels with Brakes and 2 Fixed Wheels)



Clipboard Holder Attachment

Code	Details
M1090	Heavy Duty Goods Trolley
M1845	Flat Free Wheel Kit - Includes 2 Swivel Wheels with Brakes and 2 Fixed Wheels
M1841	Clipboard Holder Attachment to suit M1090



# Heavy Duty Goods Trolley with Shelf

- An extremely versatile goods cage with the space saving benefit of being able to be collapsed easily for storage when not in use.
- Fitted with a fold up upper shelf and 270 degree opening lockable gates, this cage can be used in a single or a two shelf configuration.
- Powder coated finish
- Lower Shelf Height Space: 780mm
- Upper Shelf Height Space: 700mm
- Lower Shelf Height: 205mm
- Upper Shelf Height: 1010mm
- Rubber castors - 2 x swivel, 2 x swivel with brake
- Castors: 125mm
- Optional flat free wheel kit available - 2 x fixed wheels and 2 x swivel wheels with brakes
- Load Capacity: 500kg
- Internal Size (LxWxH): 1030x720x750mm
- Overall Size (LxWxH): 1085x795x990mm
- Shelf Size: 1030x750mm
- Unit Weight: 90kg



**Flat Free Wheel Kit**  
(Includes 2 Swivel Wheels with Brakes and 2 Fixed Wheels)



Trolley can be folded for nesting when not in use



Heavy Duty Goods Trolley with Shelf

Code	Details
M1091	Heavy Duty Goods Trolley With Shelf
M1845	Flat Free Wheel Kit - Includes 2 Swivel Wheels with Brakes and 2 Fixed Wheels





## Light Duty Mesh Cage Trolley (With Steel Shelves)

- Powder coated finish
- Key lockable
- Comes with 3 steel shelves plus the base shelf
- Shelf Heights: 630mm, 1040mm and 1450mm
- Load Capacity: 500kg (125kg per shelf, evenly distributed)
- Base Height: 280mm
- Mesh Size: 50x50mm
- Rubber castors - 2x fixed, 2x swivel with brakes
- Optional flat free wheel kit - includes 2 Swivel wheels with brakes and 2 fixed wheels



Lockable to secure contents

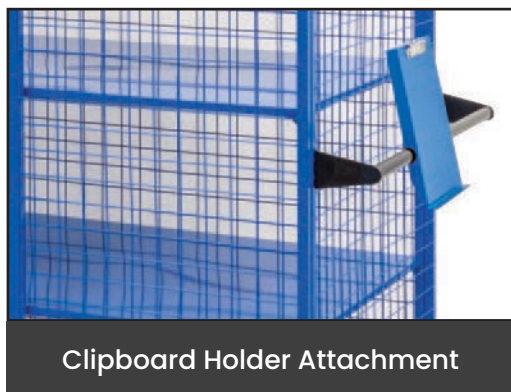

Clipboard Holder Attachment



Flat Free Wheel Kit (Includes 2 Swivel Wheels with Brakes and 2 Fixed Wheels)



Code	Details	Load Capacity (kg)	Castors (mm)	Handle Height (mm)	Shelf Size (mm)	Overall Size LxWxH (mm)	Unit Weight (kg)
M1145	Mesh Cage Trolley	500	200	950	1170x730	1300x750x1790	55
M1845	Flat Free Wheel Kit - Includes 2 Swivel Wheels with Brakes and 2 Fixed Wheels						
M1841	Clipboard Holder Attachment to suit M1145						



## Heavy Duty Sloping 4 Shelf Trolleys

- Heavy duty bolt together trolley which is great for stock picking
- 4 backwards sloping shelves which prevents items falling off
- Shelves are removable but not adjustable
- Shelves have 10° decline
- 350mm space between each shelf
- Push/pull handles on each end
- Rubber castors: 2 fixed, 2 swivel with brakes



M1080



M1845 Flat Free Wheel Kit



M1081



Shelves are reinforced underneath for extra strength

Code	Details	Load Capacity (kg)	Castors (mm)	Shelf Size (mm)	Overall Size LxWxH (mm)	Unit Weight (kg)
M1080	Sloping Shelf Trolley - 1410mm wide	500	150	1160x580	1410x620x1770	94
M1081	Sloping Shelf Trolley - 1730mm wide	500	150	1460x730	1730x770x1770	122
M1845	Pneumatic Wheel Kit to suit M1080 & M1081					

## Chair Trolley

- Lifts and moves stacks of chairs with ease
- Fitted Rubber Pads to protect the chairs
- Powder coated black finish
- Chair Capacity: 10 chairs
- Rubber castors - 2 x large fixed, 2 x swivel



Code	Load Capacity (kg)	Front Wheels (mm)	Rear Castors (mm)	Handle Height (mm)	Overall Size LxWxH (mm)	Unit Weight (kg)
M1208	70	200	75	1120	1230x495x1120	17



## 280L Plastic Bin Trolley (Blue)

- Heavy duty rotomoulded bin with 25mm steel tubular frame
- Bin is ribbed for extra strength
- Additional bins are available to purchase
- Internal Base Dimension (WxL): 500x780mm
- Internal Top Dimension (WxL): 615x910mm
- Outer Rim Dimension (WxL): 740x1045mm
- Height From Ground To Top Rim: 740mm
- Nylon castors - 2 x fixed, 2 x swivel
- Load Capacity: 400kg
- Bin Capacity: 280L



Code	Details	Castors (mm)	Overall Size LxWxH (mm)	Unit Weight (kg)
M1270B	Blue Bin Trolley (Includes Bin)	100	1170x730x800	25
M1271	Blue 280L Tub		1030x730x600	8

## 280L Plastic Bin Trolley (White)

- Heavy duty rotomoulded bin with 25mm steel tubular frame
- Bin is ribbed for extra strength
- Additional bins are available to purchase
- Internal Base Dimension (WxL): 500x780mm
- Internal Top Dimension (WxL): 615x910mm
- Outer Rim Dimension (WxL): 740x1045mm
- Height From Ground To Top Rim: 740mm
- Nylon castors - 2 x fixed, 2 x swivel
- Load Capacity: 400kg
- Bin Capacity: 280L



Code	Details	Castors (mm)	Overall Size LxWxH (mm)	Unit Weight (kg)
M1270W	White Bin Trolley (Includes Bin)	100	1170x730x800	25
M1272	White 280L Tub		1030x730x600	8



## 350L Waste Collection Trolley

- Great for use in warehouses and on sites, for general waste and rubbish
- Pull handle which releases the bin forward
- Rubber wheels - 2 x fixed, 1 x swivel



View video of this in operation here:  
[www.mhproducts.com.au/M6300](http://www.mhproducts.com.au/M6300)



Code	Load Capacity (kg)	Bin Capacity (L)	Front Wheel Size (mm)	Rear Wheel Size (mm)	Bin Size LxWxH (mm)	Unit Weight (kg)
M6300	350	350	340	125	1350x850x1040	72

## 400L Steel Waste Trolley

- The waste trolley is an ideal device for collecting and moving waste and scrap parts
- Perfect for collecting waste from production lines and engineering workshops
- Powder coated finish
- Pneumatic Wheels: 400mm diameter
- Single Rubber Rear Wheel: 200mm diameter



Rubber Wheel



Pneumatic Wheels



Code	Load Capacity (kg)	Castors (mm)	Overall Size LxWxH (mm)	Unit Weight (kg)
M6060	400	200	1390x740x920	55



## Forklift Waste Tipping Bin

- This light weight fork waste bin is great for use in warehouses and on sites for general waste and rubbish
- Fitted standard with 2 front wheels and 1 rear wheel
- Simply pull the cord or handle which releases mechanism for tipping into larger bins or skips
- Painted finish
- Polyurethane castos - 2 x fixed, 1 swivel with brake



Code	Castors (mm)	Load Capacity (kg)	Bin Capacity (L)	Fork Pocket Size (mm)	Fork Pocket Centres (mm)	Height to Top of Lip (mm)	Overall Size LxWxH (mm)	Unit Weight (kg)
M6000	125	500	150	140x55	600	710	1160x750x805	95

## Steel Triangular Frame Panel Cart

- Triangular framed panel cart is used for transporting heavy items in warehouses such as plasterboard, mattresses etc.
- Bolt together construction
- Comes with 2 fixed castors and 2 swivel castors with brakes
- Castors: 150mm
- Front Platform Height: 330mm
- Back Platform Height: 220mm



Code	Details	Load Capacity (kg)	Platform Size (mm)	Overall Size LxWxH (mm)	Unit Weight (kg)
M1230	Steel Triangular Panel Cart	500	380x1200	580x1200x1160	40
M1845	Pneumatic Wheel Kit to suit M1230				



# A Frame Trolley for Glass

- Suitable for storing & transporting glass, stone & other sheet materials
- Load is secured by 4 adjustable clamp bars
- Detachable ratchet straps supplied
- Rubber profiles protect the load from damage and help prevent movement
- Heavy duty A Frame construction for maximum stability
- 4-way fork access and crane lugs fitted for transport by forklift or crane
- 150mm poly wheels with brakes allow easy manoeuvring around the worksite
- Wheel kit is designed for quick release with a provision for storage when not in use
- M1279 base is sized (800mm) to use less space on a ute tray and fit through a standard doorway
- M1281 base is designed with racking locators to suit storage in highbay racking
- Zinc finish

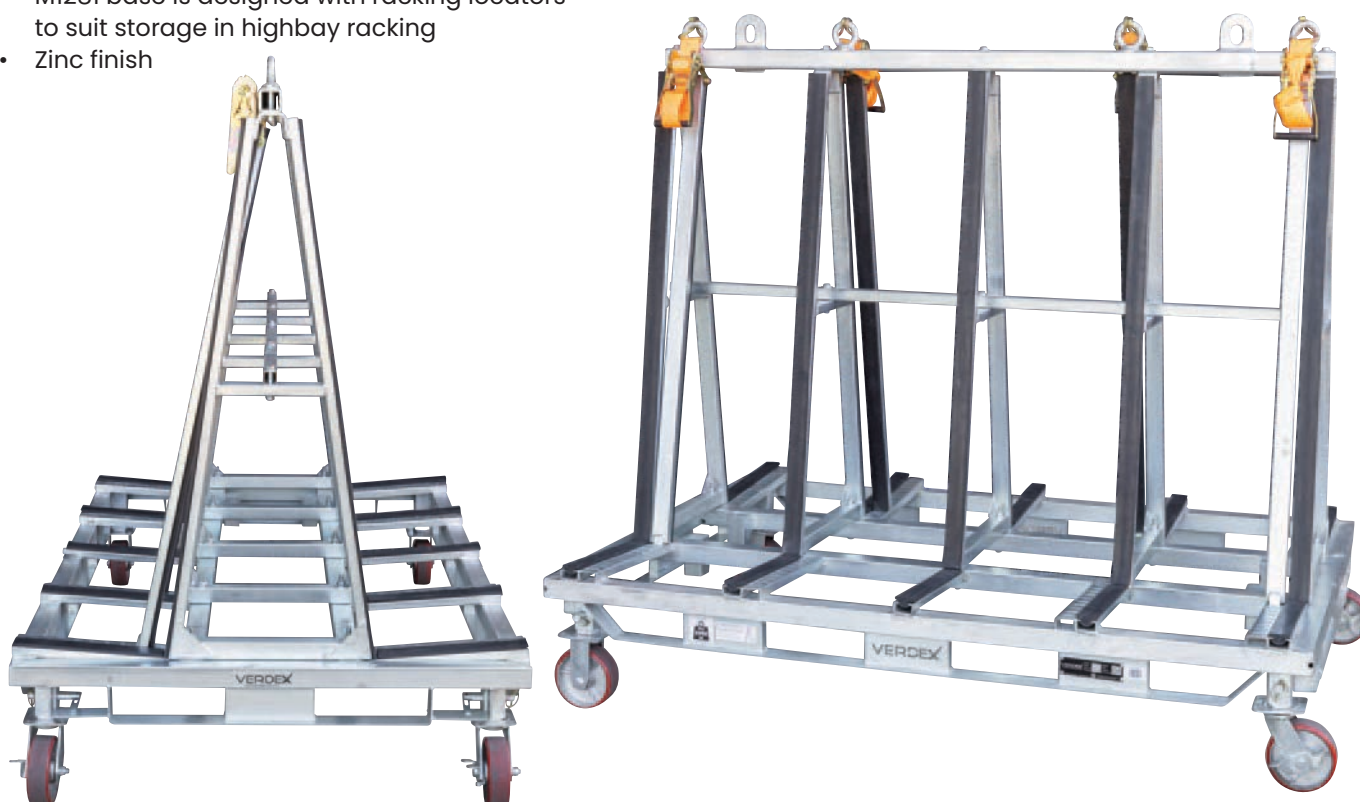

Code	Details	Maximum Load Width (mm)	Fork Pocket Size (mm)	Overall Size LxWxH (mm)	Unit Weight (kg)
M1279	Glass A-Frame Trolley - 1500mm long	215	250x80	1500x800x1620	105
M1281	Glass A-Frame Trolley - 1800mm long	340	250x80	1800x1150x1620	130



See page 255



See page 255



See page 155



## Panel Cart with Adjustable Load Bars

- The Panel Cart is ideal for moving long/bulky products
- Bars can be set at different spacing so that a variety of different sized products can be transported.
- Zinc finish
- Polyurethane castors - 2 x fixed, 2 x swivel with brakes
- Supplied standard with 2 load bars, but can be fitted with up to 5 bars at once
- Range of accessories available to suit (see page 71)



Optional Accessories available to suit - page 71



Code	Load Capacity (kg)	Castors (mm)	Base Height (mm)	Overall Size LxWxH (mm)	Unit Weight (kg)
M1293	1000	160	240	1250x700x1050	47.5

## Panel Cart with Adjustable Load Bars (Pneumatic Wheels)

- The Panel Cart is ideal for moving long/bulky products
- Bars can be set at different spacing so that a variety of different sized products can be transported.
- Zinc finish
- Pneumatic Wheels - 2 x fixed, 2 x swivel with brakes
- Supplied standard with 2 load bars, but can be fitted with up to 5 bars at once
- Range of accessories available to suit (see page 71)



Optional Accessories available to suit - page 71



Code	Load Capacity (kg)	Wheels (mm)	Base Height (mm)	Overall Size LxWxH (mm)	Unit Weight (kg)
M1294	1000	200	280	1250x700x1090	45



## A Frame Panel Cart

- The A frame panel trolley is ideal for transporting bulky items
- Optional trestle racks so that long product can be stored at different heights
- Zinc Finish
- Polyurethane castors - 2 x fixed, 2 x swivel with brakes
- Castors: 160mm
- Range of accessories available to suit (see page 71)



Optional Accessories available to suit - page 71



M1295



M1295K

Code	Details	Load Capacity (kg)	Base Height (mm)	Overall Size LxWxH (mm)	Unit Weight (kg)
M1295	A Frame Panel Cart	1000	240	1250x700x1350	55.5
M1295K	A Frame Panel Cart with Trestle Racks	1000	240	1250x700x1350	60.5

## A Frame Panel Cart (Pneumatic Wheels)

- The A frame panel trolley is ideal for transporting bulky items
- Optional trestle racks so that long product can be stored at different heights
- Zinc Finish
- Pneumatic Wheels - 2 x fixed, 2 x swivel with brakes
- Range of accessories available to suit (see page 71)



Optional Accessories available to suit - page 71



M1296



M1296K

Code	Details	Load Capacity (kg)	Wheels (mm)	Base Height (mm)	Overall Size LxWxH (mm)	Unit Weight (kg)
M1296	A Frame Panel Cart	1000	200	280	1250x700x1390	53
M1296K	A Frame Panel Cart with Trestle Racks	1000	200	280	1250x700x1390	68





## Transport Trolley with Storage Tray

- Ideal for transporting large and bulky items
- Storage tray is ideal for transporting smaller items
- Zinc Finish
- Polyurethane castors - 2 x fixed, 2 x swivel with brakes
- Tray Size (LxWxH): 1120x200x200mm
- Range of accessories available to suit (see page 71)



Optional Accessories available to suit - page 71

Code	Load Capacity (kg)	Castors (mm)	Base Height (mm)	Overall Size LxWxH (mm)	Unit Weight (kg)
M1297	1000	160	240	1250x700x1155	53

## Transport Trolley with Storage Tray (Pneumatic Wheels)

- Ideal for transporting large and bulky items
- Storage tray is ideal for transporting smaller items
- Zinc Finish
- Pneumatic Wheels - 2 x fixed, 2 x swivel with brakes
- Tray Size (LxWxH): 1120x200x200mm
- Range of accessories available to suit (see page 71)



Optional Accessories available to suit - page 71

Code	Load Capacity (kg)	Wheels (mm)	Base Height (mm)	Overall Size LxWxH (mm)	Unit Weight (kg)
M1298	1000	200	280	1250x700x1390	51



## Accessories to suit Panel Carts

- Range of accessories to suit M1280 panel trolleys

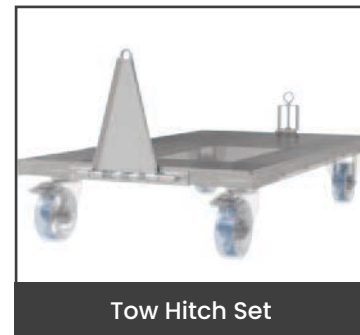

Code	Details	M1293	M1294	M1295	M1296	M1297	M1298
M1284	High Load Bar	Y	Y	-	-	Y	Y
M1285	Low Load Bar	Y	Y	-	-	Y	Y
M1287	Side Panels (set of 2)	Y	Y	-	-	Y	Y
M1289	Trestle Racks (175kg capacity per level)	-	-	Y	Y	-	-
M1291	Entry Rollers	Y	Y	Y	Y	Y	Y
M1292	Add-On Tray with one Load Bar	Y	Y	-	-	-	-
M1916	Fork Pockets	Y	Y	Y	Y	Y	Y
M1920	Trolley Towing Set	Y	Y	Y	Y	Y	Y



## Folding Hand Truck (125kg Capacity)

- Great lightweight hand trucks for general load carting
- Folds completely flat as pictured



Code	Load Capacity (kg)	Open Size LxWxH (mm)	Folded Size LxWxH (mm)	Unit Weight (kg)
M1177	125	500x520x1070	490x65x770	7.5

## Folding Hand Truck (68kg Capacity)

- Great lightweight hand trucks for general load carting
- Folds completely flat as pictured
- The M1178 trolley has a clip on attachment to fit the V-Cart folding basket
- See V-Cart basket details on page 8

The M1178 trolley fits the V-Cart folding crate



Code	Details	Load Capacity (kg)	Open Size LxWxH (mm)	Folded Size LxWxH (mm)	Unit Weight (kg)
M1178	Folding Hand Truck	68	400x400x1000	385x55x635	14.5

## Folding Hand Trolley

- Extremely light weight folding hand trolley
- Foot Plate folds up and handle collapses for easy storage when not in use
- Rubber castors
- Castors: 150mm
- Foot Plate Size (WxDx): 355x240mm

Code	Load Capacity (kg)	Closed Size WxDxH (mm)	Open Size WxDxH (mm)	Unit Weight (kg)
M1170	90	390x410x1090	390x410x1090	6





## 150kg Capacity Aluminium Hand Trolley

- Great lightweight hand truck for general load carting
- Pneumatic tyres



Plastic covered handle



Sturdy base plate



Code	Load Capacity (kg)	Castors (mm)	Foot Plate Size WxD (mm)	Open Size WxDxH (mm)	Unit Weight (kg)
M1190	150	260	355x180	520x470x1260	10

## Aluminium Convertible Hand Trolleys

- Lightweight Aluminium Convertible Hand Trolleys
- Quickly convert from a 2 wheel upright trolley to a 4 wheel platform trolley
- Load Capacity: two wheels status: 200kg; four wheels status: 250kg
- Large wheel size: 260mm
- Rubber castor wheel size: 125mm



Code	Details	Foot Plate Size WxD (mm)	Vertical Size WxDxH (mm)	Horizontal Size WxDxH (mm)	Unit Weight (kg)
M1180	1320mm High	460x180	500x470x1320	1120x500x1030	18
M1181	1560mm High	460x180	500x470x1560	1450x500x1140	18



## Heavy Duty Appliance Trolleys

- Industrial quality hand trolleys to suit a variety of applications
- Powdercoated steel frame with poly load protectors
- M1250 + M1255 are supplied with appliance strap



M1250



M1255



M1257

Code	Details	Load Capacity (kg)	Foot Size WxD (mm)	Overall Size WxH (mm)	Unit Weight (kg)
M1250	Appliance Trolley - Stair Climber	350	450x200	610x1520	22
M1255	Appliance Trolley - Flat Free	350	450x200	610x1520	19
M1257	P Handle Trolley with extended Foot - Flat Free	300	350x240	525x1305	15

## Keg Trolley

- Highly manoeuvrable
- Ergonomically designed to prevent back strain
- Standard unit fitted with solid 250mm polyurethane wheels
- Overall Size (WxH): 530x1150mm
- Tyre Type: Solid Polyurethane
- Suits all Australian kegs



Code	Castors (mm)	Load Capacity (kg)	Overall Size WxDxH (mm)	Unit Weight (kg)
M1212	250	100	530x1150	10



## Court / Solicitors File Trolleys

- These steel basket court trolleys are ideal for solicitors documents
- The trolley has 3 separate levels which are designed specially to fit lever arch files
- The 2 shelves fold back which gives more space for larger items and boxes
- Available with solid or pneumatic wheels
- Shelf Depth: 340mm
- Optional rain cover also available as pictured
- Court trolleys are supplied assembled ready for immediate use



**M1162**  
Vinyl Rain Cover



**M1160**  
Solid Tyres



**M1161**  
Pneumatic Tyres

Code	Details	Front Castors (mm)	Rear Castors (mm)	Overall Size LxWxH (mm)	Unit Weight (kg)
M1160	Court Trolley - Solid Rear Wheels	80	250	620x640x1160	20
M1161	Court Trolley - Pneumatic Rear Wheels	80	270	620x740x1160	20
M1162	Vinyl Rain Cover to suit Court Trolleys				

## Gas Cylinder Trolleys

- Ideal for transporting gas cylinders
- Supplied with securing chains as pictured



**M1210**  
Single Cylinder Trolley



**M1211**  
Double Cylinder Trolley

Code	Details	Castors (mm)	Cylinder Size Dia. (mm)	Overall Size WxDxH (mm)	Unit Weight (kg)
M1210	Single Cylinder Trolley	200	140-250	600x600x1360	17
M1211	Double Cylinder Trolley	390	210-250	700x700x1380	46



## Gas Cylinder Trolley Cage

- Suitable for oxygen and acetylene gas cylinders with provision to store hoses inside the cage
- Craneable trolley designed to carry one type "G" Oxygen and one type "G" Acetylene gas cylinder
- Supplied with an internal load binder to securely fasten both cylinders
- Fitted with a handle, crane lift point and 400mm diameter air inflated rubber wheels
- Supplied with 1T crane lifting sling
- Enamel paint finish
- HGC: 167mm
- Supplied flatpacked



Rubber air filled wheels



Code	Safe Working Load (kg)	Load Centre (mm)	Fork Pocket Size (mm)	Fork Pocket Centres (mm)	Overall Size LxWxH (mm)	Unit Weight (kg)
M1215	250	202	165x45	480	882x615x1371	55

## Pipe Trolley

- Heavy duty construction for maximum stability
- 8 spaces available for sorting and accessing pipes
- Arm stops prevent items falling off
- 4 corner posts supplied for fitting to base frame
- Poly/cast wheels - 2x fixed, 2x swivel with brakes
- Zinc finish

Designed for long length materials such as pipe and conduit



Code	Working Load Limit (kg)	Castors (mm)	Overall Size LxWxH (mm)	Unit Weight (kg)
M1280	2000	150	1895x1065x1790	112



# Galvanised Drum Trolley with Bund

- This trolley is designed to carry 1 drum which is mounted on the rack provided for easy dispensing
- The bin tray has a drain plug for draining the bin
- Finish: Galvanised

Trolley doesn't come with the drum



Code	Spill Bin Capacity (L)	Overall Size WxDxH (mm)	Unit Weight (kg)
M7583	230	610x1210x431	90



See page 132



See page 225



See page 256



See page 214



See page 88

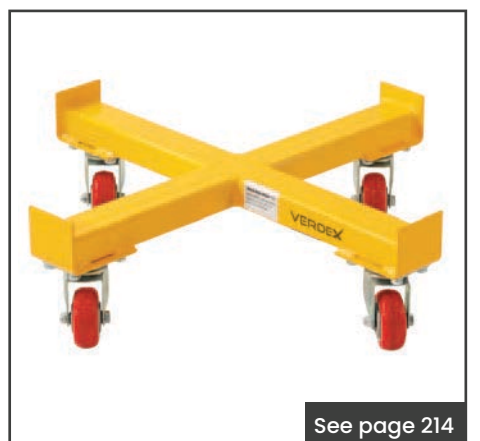

See page 214





## Heavy Duty 3 Sided Mesh Cage Trolley

- These cage trolleys are an ideal trolley for stock packing and goods movement
- The base folds up for compact storage
- Optional heavy duty removable shelves
- Flat free wheel kit available to suit (pictured)
- These trolleys come with a removable front bar
- Comes with signboard area on the side
- Rubber castors- 2 x swivel, 2 x swivel with brakes
- Powder coated finish
- Base Height: 200mm
- Shelf can be positioned on mesh with 60mm increment
- Shelf Size: 1020x750mm

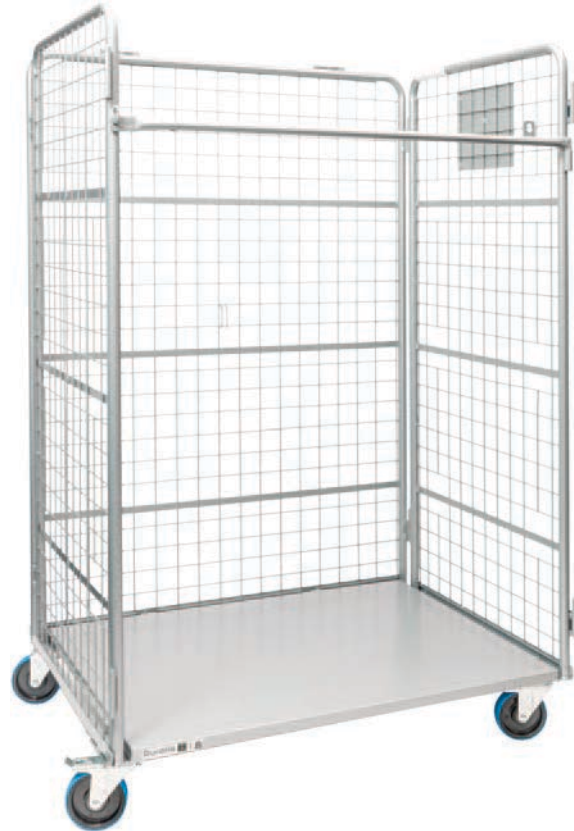

Code	Castors (mm)	Load Capacity (kg)	Shelf Capacity (kg)	Overall Size LxWxH (mm)	Unit Weight (kg)
M1900	125	500	125	1100x850x1700	62

## Heavy Duty Mesh Cage Trolley

- These cage trolleys are an ideal trolley for stock packing and goods movement
- The base folds up for compact storage
- Optional heavy duty removable shelves available
- Flat free wheel kit available to suit
- These trolleys come with a removable front bar
- Comes with signboard area on the side
- Rubber castors- 2 x swivel, 2 x swivel with brakes
- Powder coated finish
- Base Height: 200mm
- Shelf can be positioned on mesh with 60mm increment
- Shelf Size: 1020x750mm



Code	Castors (mm)	Load Capacity (kg)	Shelf Capacity (kg)	Overall Size LxWxH (mm)	Unit Weight (kg)
M1904	125	500	125	1100x850x1700	62



## Heavy Duty Mesh Cage Trolley (with Roof)

- These cage trolleys are an ideal trolley for stock packing and goods movement
- The base folds up for compact storage
- Roof for fully securing contents of cage
- Optional heavy duty removable shelves
- Flat free wheel kit available to suit
- These trolleys come with a removable front bar
- Comes with signboard area on the side
- Rubber castors- 2 x swivel, 2 x swivel with brakes
- Powder coated finish
- Base Height: 200mm
- Shelf can be positioned on mesh with 60mm increment
- Shelf Size: 1020x750mm



Code	Castors (mm)	Load Capacity (kg)	Shelf Capacity (kg)	Overall Size LxWxH (mm)	Unit Weight (kg)
M1905	125	500	125	1100x850x1700	62

## Accessories to suit Heavy Duty Mesh Cage Trolleys



M1845 - Flat Free Wheel Kit



M1901 - Optional Shelves



M1673 - Optional Clipboard



M1905 with 2x M1901 &amp; M1845

Code	Details
M1901	Optional Shelves to suit Mesh Cage Trolleys
M1845	Flat Free Wheel Kit - Includes 2 Swivel Wheels with Brakes and 2 Fixed Wheels
M1673	Optional Clipboard Holder Attachment to suit Mesh Cage Trolleys



## Open Front Cage Trolley

- Ideal for stock packing, goods movement and more.
- Garment rail for transporting hanging goods
- Removable back panel (supplied as 3 panels)
- Multiple accessories available - see page 83
- Able to fit up to 6 shelves at 200mm pitch
- Bolt together construction
- Zinc plated finish
- Rubber Castors - 2 x swivel, 2 x swivel with brakes
- Internal Size (LxWxH): 1305x675x1476mm
- Handle Height: 1065mm
- Base Height: 223mm



Code	Castors (mm)	Load Capacity (kg)	Overall Size LxWxH (mm)	Unit Weight (kg)
M1930	125	350	1472x687x1710	47

## Fully Lockable Cage Trolley with Doors & Roof

- Ideal for stock packing, goods movement and more.
- Roof and doors for securing goods during transport
- Removable back panel (supplied as 3 panels)
- Multiple accessories available - see page 83
- Able to fit up to 6 shelves at 200mm pitch
- Bolt together construction
- Zinc plated finish
- Rubber Castors - 2 x swivel, 2 x swivel with brakes
- Internal Size (LxWxH): 1305x675x1476mm
- Handle Height: 1065mm
- Base Height: 223mm



Code	Castors (mm)	Load Capacity (kg)	Overall Size LxWxH (mm)	Unit Weight (kg)
M1931	125	350	1472x687x1710	72



## Cage Trolley with 3 Mesh Tray Shelves

- Ideal for stock packing, goods movement and more.
- Supplied with 3 tray mesh shelves (MI913) – centre shelf is adjustable
- Multiple accessories available – see page 83
- Zinc plated finish
- Rubber Castors – 2 x swivel, 2 x swivel with brakes
- Internal Size (LxWxH): 1305x675x1476mm
- Handle Height: 1065mm
- Base Height: 223mm



Code	Castors (mm)	Load Capacity (kg)	Overall Size LxWxH (mm)	Unit Weight (kg)
MI932	125	350	1472x687x1710	58

## Fully Lockable Cage Trolley with Doors & Roof

- Ideal for stock packing, goods movement and more.
- Roof and doors for securing goods during transport
- Removable back panel (supplied as 3 panels)
- Multiple accessories available – see page 83
- Able to fit up to 6 shelves at 200mm pitch
- Bolt together construction
- Zinc plated finish
- Rubber Castors – 2 x swivel, 2 x swivel with brakes
- Internal Size (LxWxH): 1305x675x1476mm
- Handle Height: 1065mm
- Base Height: 223mm



Code	Castors (mm)	Load Capacity (kg)	Overall Size LxWxH (mm)	Unit Weight (kg)
MI933	125	350	1472x687x1710	87



# Cage Trolley with Basket

- Ideal for stock packing, goods movement and more.
- Garment rail for transporting hanging goods
- Lower basket to stop boxes falling off in transport (removable sides if not required)
- Multiple accessories available - see page 83
- Able to fit up to 4 shelves (M1912, M1913, M1914) at 200mm pitch
- Bolt together construction
- Zinc plated finish
- Rubber Castors - 2 x swivel, 2 x swivel with brakes
- Internal Size (LxWxH): 1305x675x1476mm
- Handle Height: 1065mm
- Base Height: 223mm

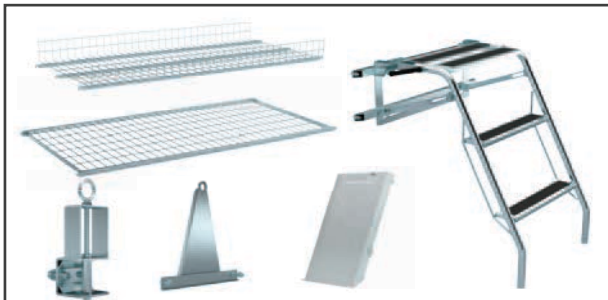

See accessories to suit on page 83

Code	Castors (mm)	Load Capacity (kg)	Overall Size LxWxH (mm)	Unit Weight (kg)
M1934	125	350	1472x687x1710	43





## Accessories to suit 1910 Trolleys

- Range of accessories available to suit cage trolleys

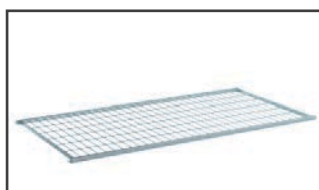

M1912 - Flat Mesh Shelf

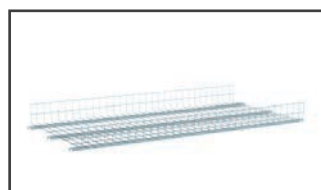

M1913 - Tray Mesh Shelf

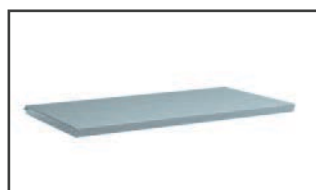

M1914 - Reversible Solid/Tray Shelf

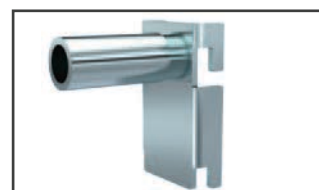

M1915 - Sloping Shelf Bracket

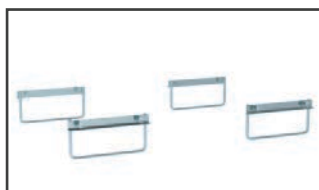

M1916 - Fork Pockets



M1917 - Centre Wheel Kit

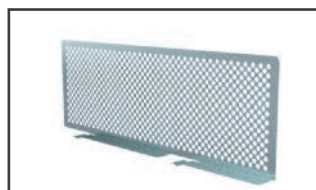

M1918 - Shelf Divider

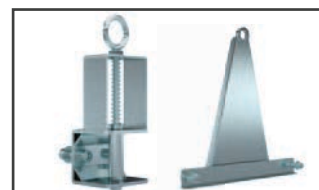

M1920 - Trolley Towing Set



M1921 - Retractable Ladder



M1922 - Handles to suit Ladder



M1673 - Clipboard



M1840 - Drink Holder

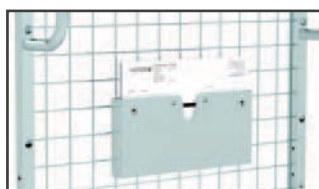

M1848 - A4 Pocket



M1849 - Scanner Holder

See video of 1910 Cage Trolleys and accessories to suit



View video of this in operation here  
[www.mhaproducts.com.au/M1930](http://www.mhaproducts.com.au/M1930)



Code	Details	M1930	M1931	M1932	M1933	M1934
M1912	Flat Mesh Shelf	Y	Y	-	-	Y
M1913	Tray Mesh Shelf	Y	Y	Y	-	Y
M1914	Reversible Solid/Tray Shelf	Y	Y	-	Y	Y
M1915	Sloping Shelf Bracket to suit M1912 & M1914 Shelves	Y	Y	-	Y	Y
M1916	Fork Pockets	Y	Y	Y	Y	Y
M1917	Centre Wheel Kit	Y	Y	Y	Y	Y
M1918	Shelf Divider to suit Mesh Shelves (M1912 & M1913)	Y	Y	Y	-	Y
M1920	Trolley Towing Set	Y	Y	Y	Y	Y
M1921	Retractable Ladder	Y	Y	Y	Y	Y
M1922	Handles to suit Retractable Ladder (M1921)	Y	Y	Y	Y	Y
M1673	Clipboard Writing Panel	Y	Y	Y	Y	Y
M1840	Drink Holder	Y	Y	Y	Y	Y
M1848	A4 Pocket	Y	Y	Y	Y	Y
M1849	Scanner Holder	Y	Y	Y	Y	Y

