

Lifting & Handling Equipment

VERDEX
Incorporates **MHA**



Scissor Lift Trolleys (Single Scissor)

- These units help take the strain out of loading and unloading items from raised levels.
- The table is elevated by a pump action foot pedal and smoothly lowered by a hand operated release trigger.
- Foot operated hydraulic operation
- Lever release control
- Safety overload bypass valve
- Stepless rate of lowering regardless of load weight
- Durable powder coated finish
- Polyurethane castors - 2 x fixed, 2 x swivel with brakes



Code	Load Capacity (kg)	Castors (mm)	Table Size LxW (mm)	Lifting Range (mm)	Unit Weight (kg)
V2000	150	100	700x450	220-720	46
V2001	300	125	850x500	340-880	77
V2002	500	125	850x500	340-880	81
V2003	750	125	1000x510	420-990	175



Scissor Lift Trolleys (Double Scissor)

- These units help take the strain out of loading and unloading items from raised levels.
- The table is elevated by a pump action foot pedal and smoothly lowered by a hand operated release trigger.
- Foot operated hydraulic operation
- Lever release control
- Safety overload bypass valve
- Stepless rate of lowering regardless of load weight
- Durable powder coated finish
- Polyurethane castors - 2 x fixed, 2 x swivel with brakes



Code	Load Capacity (kg)	Castors (mm)	Table Size (mm)	Lifting Range (mm)	Unit Weight (kg)
V2010	350	125	910x500	355-1300	105
V2011	500	150	1010x520	435-1585	168
V2012	700	125	1220x610	445-1500	195

Rough Terrain Scissor Lift Trolley

- Rough terrain scissor lift trolley is ideal for outdoor applications
- Foot Pedal Cycles to Max Height: 25
- Durable powder coated finish
- Rubber castors - 2 x fixed, 2 x swivel with brakes
- Min. Height of Table: 330mm
- Max Lift Height: 1000mm
- Overall Length: 1120mm



Code	Load Capacity (kg)	Castors (mm)	Table Size (mm)	Lifting Range (mm)	Unit Weight (kg)
V2015	200	200	1000x500	340-1010	71

Electric Scissor Lift Trolleys

- The battery electric scissor lift trolleys are available in both standard lift and high lift versions and 3 load capacities; 300kg, 500kg and 1000kg.
- Smooth lifting of heavy loads with ease
- Automatic 12v charger
- Push button, battery/hydraulic operation
- Polyurethane castors - 2 x fixed, 2 x swivel with brakes



V2060



V2063



V2064

Code	Load Capacity (kg)	Castors (mm)	Table Size (mm)	Lifting Range (mm)	Unit Weight (kg)
V2060	300	125	850x500	290-880	115
V2063	500	150	1010x520	495-1618	198
V2064	1000	150	1200x800	430-1220	225



Extra Large Scissor Lift Trolleys

- The extra large scissor lift trolleys are excellent for handling large bulky items.
- The table is elevated by a pump action foot pedal and smoothly lowered by a hand operated release trigger.
- Foot operated hydraulic operation
- Lever release control
- Safety overload bypass valve
- Positive braking system on rear wheels
- Durable powder coated finish
- Stepless rate of lowering regardless of load weight
- Available in 500kg and 1000kg load capacities
- V2020: Polyurethane castors- 2 x fixed, 2 x swivel with brakes
- V2021: Nylon castors- 2 x fixed, 2 x swivel with brakes



Code	Load Capacity (kg)	Castors (mm)	Table Size (mm)	Lifting Range (mm)	Unit Weight (kg)
V2020	500	125	1600x810	290-915	154
V2021	1000	180	2035x750	360-1360	198



Aluminium Scissor Lift Trolley

- Extremely lightweight - great for vehicle transport
- Aluminium construction with a painted finish
- Foot operated hydraulic operation
- Lever release control
- Safety overload bypass valve
- Stepless rate of lowering regardless of load weight
- Foldable handle
- Polyurethane castors - 2 x fixed, 2 x swivel with brakes



Code	Load Capacity (kg)	Castors (mm)	Handle Height (mm)	Table Size (mm)	Lifting Range (mm)	Unit Weight (kg)
V2030	100	100	1000	700x450	265-755	24

Stainless Steel Scissor Lift Trolleys

- These stainless steel scissor lift trolleys are great for use in food, pharmaceutical or hygiene areas.
- Foot operated hydraulic operation
- Lever release control
- Safety overload bypass valve
- Stepless rate of lowering regardless of load weight
- Scissor and pump unit is galvanised
- Stainless Steel Grade 304
- Polyurethane castors - 2 x fixed, 2 x swivel with brakes



Code	Load Capacity (kg)	Castors (mm)	Table Size (mm)	Handle Height (mm)	Lifting Range (mm)	Unit Weight (kg)
V2040	100	100	700x445	1000	250-1220	55
V2041	350	100	830x500	1000	330-1295	78



Galvanised Scissor Lift Trolley

- Galvanised version which is great for food and medical areas
- Foot operated hydraulic operation
- Lever release control
- Double scissor lift version
- Safety overload bypass valve
- Stepless rate of lowering regardless of load weight
- Polyurethane castors - 2 x fixed, 2 x swivel with brakes



Code	Load Capacity (kg)	Castors (mm)	Table Size (mm)	Lifting Range (mm)	Unit Weight (kg)
V2050	150	100	830x500	435-1430	80

Spring Scissor Lift Trolleys (With Centre Wheel Kit)

- Self-leveling, fully adjustable, weight sensitive
- Designed to maintain an ideal working height for assembly lines and loading / unloading operations
- Balance achieved by double springs fitted to the shock absorbers
- Simple to operate spring tension adjustment
- Centre wheel kit is ideal for movement in small spaces
- Polyurethane castors - 2 x fixed centre, 4 x swivel with brakes
- Centre Castors: 200mm



V2075



V2076

Code	Details	Load Capacity (kg)	Swivel Castors (mm)	Table Size (mm)	Lifting Range (mm)	Unit Weight (kg)
V2075	Scissor Lift Trolley	300	100	830x500	360-770	65
V2076	Scissor Lift Trolley (X Large)	300	100	1200x500	360-770	82

Self Propelled Electric Scissor Lift Trolley (With Cage)

- These self propelled lift tables take the effort of having to push heavy items manually as well as having electric operated lift.
- With the centre drive wheel it makes it extremely easy to manoeuvre loads in narrow aisles or tight spaces.
- Comes complete with side cage as pictured which can be easily removed if not required
- 4 x swivel castors with brakes
- 2 x pneumatic centre drive wheels
- Batteries: 2x12V 33Ah
- Curtis Controller: 70A
- Motor (Driving): 400W
- Motor (Lifting): 400W
- Lifting Time: 17 seconds
- Castors: 150mm
- Middle Wheels: 275mm



Code	Load Capacity (kg)	Table Size (mm)	Lifting Range (mm)	Overall Size LxWxH (mm)	Unit Weight (kg)
V2080	400	1000x600	460-940	1240x600x1100	180

Self Propelled Electric Scissor Lift Trolley (Single Scissor)

- Powered Lift and Drive makes this unit ideal for a wide range of applications, including in hospitals and libraries
- 2 x rear swivel castors with brakes
- 2 x pneumatic drive wheels
- Batteries: 2x12V 33Ah
- Curtis Controller: 70A
- Motor (Driving): 400W
- Motor (Lifting): 400W
- Lifting Time: 17 seconds
- Rear Castors: 150mm
- Front Wheels: 275mm



Code	Load Capacity (kg)	Table Size (mm)	Lifting Range (mm)	Overall Size LxWxH (mm)	Unit Weight (kg)
V2081	400	1000x600	460-900	1240x600x1100	180



Self Propelled Electric Scissor Lift Trolley (Double Scissor)

- Double Scissor lift is optimal for reaching high spaces with heavy loads
- 2 x rear swivel castors with brake
- 2 x pneumatic drive wheels
- Castors: 150mm
- Batteries: 2x12V 33Ah
- Curtis Controller: 70A
- Motor (Driving): 400W
- Motor (Lifting): 400W
- Lifting Time: 17 seconds
- Lifting Range: 460-1600mm
- Front Wheels: 275mm



Code	Load Capacity (kg)	Table Size (mm)	Overall Size LxWxH (mm)	Unit Weight (kg)
V2082	400	1100x600	1340x660x1100	234



Watch a video of this in operation on our website here: www.verdex.com.au/V2082

Self Propelled Electric Scissor Lift Trolley with Cage (Double Scissor)

- These self propelled lift tables take the effort of having to push heavy items manually as well as having electric operated lift.
- With the centre drive wheel it makes it extremely easy to manoeuvre loads in narrow aisles or tight spaces.
- Comes complete with side cage as pictured which can be easily removed if not required
- Includes centre wheel unit
- 4 x swivel castors with brake
- 2 x pneumatic centre drive wheels
- Batteries: 2x12V 33Ah
- Curtis Controller: 70A
- Motor (Driving): 400W
- Motor (Lifting): 400W
- Lifting Time: 17 seconds
- Castors: 150mm
- Middle Wheels: 260mm
- Cage Height: 450mm



Code	Load Capacity (kg)	Table Size (mm)	Lifting Range (mm)	Overall Size LxWxH (mm)	Unit Weight (kg)
V2083	400	1000x600	450-1625	1340x600x1055	234



Super Low Profile Lift Tables

- These lift tables achieve a super low closed height, eliminating the need for a pit installation
- The upper platform is fitted with a safety perimeter to prevent descent on contact with obstructions
- 24v control unit with up/down buttons & emergency stop
- Power supply is AC 415V/50HZ/3phase
- The external power pack is equipped with a relief valve against overloading and a compensated flow valve for controlling lowering speed
- Hose burst safety valve which stops the table lifting incase of a hose breakage

35mm low platform allows easy pallet truck entry



Easy to use controller which sits 900mm off ground level



Code	Load Capacity (kg)	Platform Size WxL (mm)	Lifting Range (mm)	Overall Size LxWxH (mm)	Unit Weight (kg)
V2122	1500	1200x1270	35-800	1850x1850x350	380



Low Profile Pallet Lift Tables

- Using pallet lift tables elevates pallets to the optimum lift height reducing the risk of repetitive strain injury and increasing productivity.
- Supplied with entry ramp to allow pallet truck entry
- Can be supplied with optional rotator ring
- Tables are specially made for handling pallets, no need for a pit or load ramps
- Upper platform fitted with safety perimeter to prevent descent on contact with obstructions
- 24v control box with UP and DOWN buttons and emergency stop
- External power pack equipped with a relief valve against overloading and a compensating flow valve for controlling lowering speed
- Power Supply: 240v (3 phase 415v available if required)
- Hose burst safety valve to stop the lift table lowering in case of hose breakage
- Removable lifting eyes to facilitate handling and installation of the lift table
- Oil-less bushings on pivot points



Ramp supplied with lift table



Watch a video of this in operation on our website here: www.verdex.com.au/v2100



Code	Load Capacity (kg)	Platform Size LxW (mm)	Lifting Range (mm)	Lifting Time	Unit Weight (kg)
V2100	1000	1450x1140	85-860	20 secs	357
V2101	2000	1600x1200	105-870	20 secs	419



Electric Scissor Lift Tables

Lift tables can be applied in many work places to increase productivity and safety. Loads can be elevated or lowered to optimum heights at the push of a button.

- Heavy duty design and construction
- High quality European power packs
- Suitable for on floor applications or in floor pit applications
- Self lubricating bushings on pivot points
- Removable lifting eyes to facilitate installation and maintenance
- 240V power supply (3 phase available as an option)
- Upper platform fitted with aluminium safety bar preventing descent on contact with obstructions
- Low volt (24v) control box with up-down buttons.
- Internal power pack equipped with relief valve against overloading and compensated flow valve for controlled lowering speed
- Heavy duty cylinders with drainage system and check valve to stop the lift table lowering in case of hose burst
- Safety clearance between scissors to prevent trapping during operation.
- Push button pendant control with up, down and emergency stop

Small Platform Electric Scissor Lift Table

Small platform lift tables are ideal for lifting small products in tight spaces

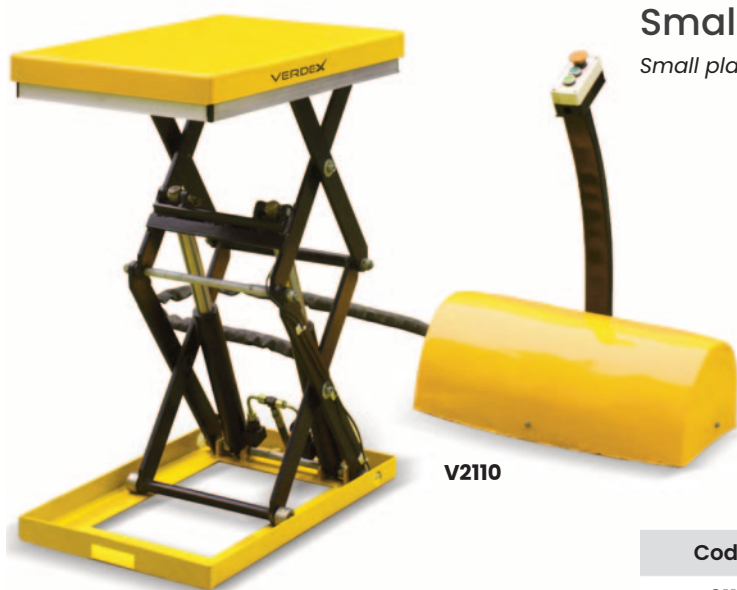

Code	V2110
Capacity	500kg
Table Size	610x910mm (WxL)
Base Frame Size	450x700mm (WxL)
Min Height	162mm
Max Height	950mm
Raise Time	17-22 seconds
Unit Weight	98kg
Power Supply	240 volt

Other custom sizes available - contact us!

Code	Description
V2110	Small Platform Scissor Lift Table (500kg capacity)

Single Scissor Electric Scissor Lift Tables

Single scissor lift tables for lifting various sized loads.

These tables are ideal for applications where

Code	V2150	V2151
Capacity	2000kg	2000kg
Table Size	850x1300mm (WxL)	1000x2000mm (WxL)
Base Frame Size	785x1255mm (WxL)	785x1630mm (WxL)
Min Height'	230mm	250mm
Max Height	1000mm	1300mm
Raise Time	20-25 seconds	25-30 seconds
Unit Weight	235kg	315kg
Power Supply	240 volt	240 volt

Other custom sizes available - contact us!

Code	Description
V2150	Single Scissor Electric Lift Table
V2151	Single Scissor Electric Lift Table





Double Scissor Electric Lift Tables

Code	V2165	V2166
Capacity	2000kg	4000kg
Table Size	850x1300mm (WxL)	1200x1720mm (WxL)
Base Frame Size	785x1220mm (WxL)	900x1600mm (WxL)
Min Height	360mm	400mm
Max Height	1780mm	2050mm
Raise Time	35-45 seconds	55-65 seconds
Unit Weight	295kg	520kg
Power Supply	240 volt	240 volt

Other custom sizes available - contact us!

Code	Description
V2165	Double Scissor Electric Lift Table
V2166	Double Scissor Electric Lift Table



Extra Long Scissor Electric Lift Table

Extra long lift tables are perfect for oversized goods



Code	M2155-16
Capacity	2000kg
Table Size	820x2500mm (WxL)
Base Frame Size	640x2460mm (WxL)
Min Height	205mm
Max Height	1000mm
Raise Time	40-45 seconds
Unit Weight	265kg
Power Supply	3 Phase 415 volt

Other custom sizes available - contact us!

Code	Description
V2155	Extra Long Electric Scissor Lift Table

High-Lift Electric Scissor Lift Tables

High lift scissor lift tables are ideal for moving goods up levels, including on construction sites and to mezzanines

Code	V2161	V2160
Capacity	2000kg	400kg
Table Size	1000x1700mm (WxL)	1200x1720mm (WxL)
Base Frame Size	1010x1606mm (WxL)	1000x1600mm (WxL)
Min Height	560mm	600mm
Max Height	3000mm	4140mm
Raise Time	70 seconds	30-40 seconds
Unit Weight	750kg	547kg
Power Supply	240 volt	240 volt

Other custom sizes available - contact us!

Code	Description
V2161	High Lift Electric Scissor Lift Table
V2160	High Lift Electric Scissor Lift Table



Pneumatic Scissor Lift Table

- This pneumatic scissor lift table runs on air with no electrics or hydraulics used – great for pharmaceutical and medical areas as its extremely clean and quite operation
- Safe, clean and extremely low maintenance
- Raise Time: 40-45 seconds
- Air Pressure 263 MPA



V2105 collapsed



Watch a video of this in operation on our website here: www.verdex.com.au/V2105

Code	Load Capacity (kg)	Table Size WxL (mm)	Lifting Range (mm)	Base Frame Size WxL (mm)	Unit Weight (kg)
V2105	1000	812x1220	230-840	784x1220	263

Optional Accessories for Scissor Lift Tables

As well as the following optional accessories, Verdex has the capability to manufacture custom solutions for your application. Give us a call on 1800 750 500 to discuss!

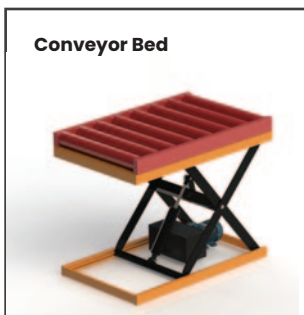

Conveyor Bed

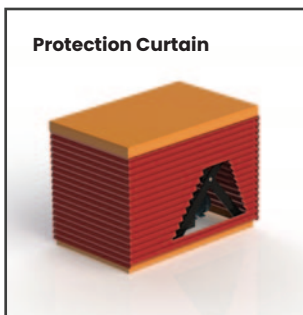

Protection Curtain



Raise and Tilt Platform



Round Turntable



Trolley - Wheels Mounted

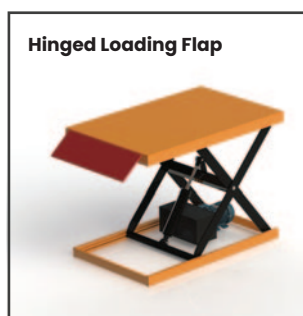

Hinged Loading Flap

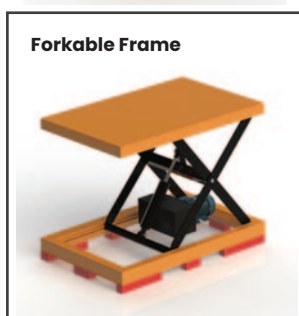

Forkable Frame

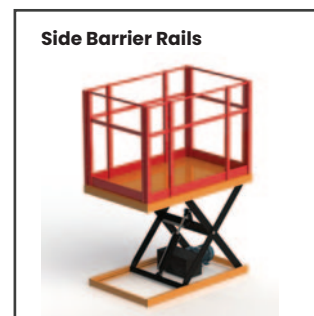

Side Barrier Rails



Bishamon Pneumatic Rotating Pallet Positioner (For Varying Pallet Weights)

The most advanced pallet positioner available!

- EZ Loaders are designed to eliminate worker bending by automatically raising and lowering pallets during loading or unloading without the use of mechanical springs, motors or hydraulics.
- The new EZ loader can now handle a wide range of weight capacities from 110 kilos to 1800 kilos.
- The EZ Adjust knob - a three position knob that allows adjustment of the collapsed capacity without changing the air pressure.
- EZ Loaders also allow easy pallet rotation for near-side loading so the worker does not have to reach or strain.
- As the load weight changes, the EZ Loader automatically adjusts, keeping the top of the load at a convenient working height.
- The patented pneumatic system found only on the EZ Loader has proven to be the choice of industry professionals worldwide.



EZ adjust knob provides up to 550kgs of capacity adjustment with the turn of a knob

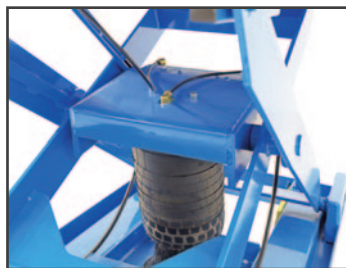

Patented self-contained pneumatic system offers unsurpassed performance



Rollers are entrapped in the base frame and platform for added stability



Bellows Skirting (V2172)



Rotator Ring Brake (V2171)



Watch a video of this in operation on our website here: www.verdex.com.au/V2175



Code	Details	Load Capacity (kg)	Rotator Ring Dia. (mm)	Lifting Range (mm)	Base Frame Size (mm)	Unit Weight (kg)
V2175	EZ Loader	110-1800	1092	267-775	1245x617	172
V2171	Rotator Ring Brake					
V2172	Bellows Skirting to suit V2175					



Spring Loaded Rotating Pallet Tables

- The pallet elevator keeps the active layer of the load at or above waist height, eliminating bending and lifting.
- This pallet elevator can be moved with a standard Pallet Truck
- It is proving highly effective at reducing the incidences of repetitive strain and back injury.
- The construction of the pallet elevator is a scissor type action with varying springs which can be adjusted for different heights
- Turntable allows operator to rotate the load with minimal stretching and reaching.
- No ground fixing required, however the unit is fitted with brackets to allow it to be secured to the ground if required
- Available in Galvanised or Powder Coated finishes
- Fork Pocket Centres: 615mm



V2134
(powder coated model)



V2135
(galvanised model)



Bolt on Brackets

PVC Protection screen supplied standard
Rotating Tops (can be fixed if required)

Springs to suit a wide range of pallet weights

Easy spring changing lock mechanism

Fork pocket centres for easy relocation



Watch a video of this in operation on our website here:
www.verdex.com.au/V2135



Code	Details	Load Capacity (kg)	Table Diameter (mm)	Lifting Range (mm)	Fork Pocket Size (mm)	Unit Weight (kg)
V2134	Powder coated	2000	1110	290-750	300x90	195
V2135	Galvanised	2000	1110	290-750	300x90	195



Rotatable Electric Lift Table

- The pallet elevator is electric up and down via foot pedal and manual rotating top
- It is ideal for varying weight pallets as there is no need to change springs
- Turntable allows the operator to rotate the load with minimal stretching and reaching while controlling the up/down operation via the foot pedal controls
- Can be easily moved around factory with a forklift
- No ground fixing required
- Power: 240V



Foot Pedal to raise and lower platform

Code	Load Capacity (kg)	Lifting Range (mm)	Table Diameter (mm)	Base Frame Size LxW (mm)	Unit Weight (kg)
V2125	2000	300-710	1110	935x915	175

Powered Rotatable Electric Lift Table

- The pallet elevator is electric up, down and rotating top via pendant control
- It is ideal for varying weight pallets as there is no need to change springs
- Powered Rotation in both directions which can be set to rotate continuously.
- Can be easily moved around factory with a forklift
- No ground fixing required
- Power: 240V



Pendant Control Unit



Watch a video of this in operation on our website here: www.verdex.com.au/v2126



Code	Load Capacity (kg)	Lifting Range (mm)	Table Diameter (mm)	Base Frame Size LxW (mm)	Unit Weight (kg)
V2126	2000	340-710	1110	935x915	190



Heavy Duty Pallet Stands

- The heavy-Duty steel constructed Pallet Stand keeps the load off the ground limiting the need for bending and lifting.
- This Pallet Stand has accessories tailored for all applications and is proving highly effective at reducing the incidences of repetitive strain and back injury.
- Optional Accessories to suit below
- Steel Construction with a powdercoated finish
- V7908 Height: 250-400mm
- V7909 Height: 500-650mm
- Platform Size: 1250x1250mm
- Optional 100mm Castor Kit: 2 x Fixed, 2 x Swivel with brakes (Adds 160mm Height)



V7908
Heavy Duty Pallet Stand
(with Short Adjustable Legs)



V7909
Heavy Duty Pallet Stand
(with Tall Adjustable Legs)

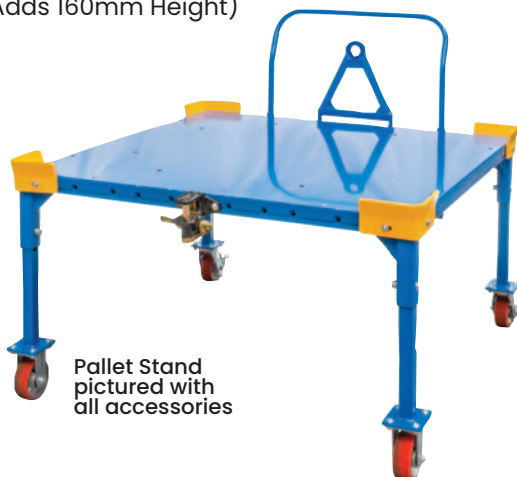

Pallet Stand
pictured with
all accessories



V7908 pictured
with V7903,
V7905 & V7907

V7903 Corner Gussets



V7905 Wheel Kit



V7906 Adjustable Handle



V7907 Tow Hitch Kit



V7904 Steel Cap Base

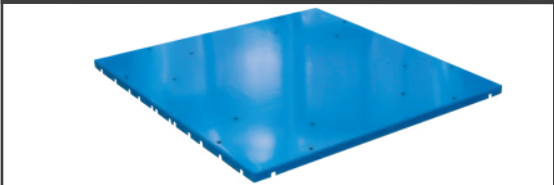

Code	Description	Capacity (kg)	Unit Weight (kg)
V7908	Heavy Duty Pallet Stand with Short Adjustable Legs	2000	40
V7909	Heavy Duty Pallet Stand with Tall Adjustable Legs	2000	43
V7903	Gussets to suit V7908 & V7909		7.5
V7904	Steel Cap to suit V7908 & V7909		24.5
V7905	Castor Kit to suit V7908 & V7909	2000	11
V7906	Handle to suit V7908 & V7909		4.65
V7907	Tow Hitch Kit to suit V7908 & V7909	4500	7





IBC Tilting Stand

- The IBC Tilting Stand is designed to keep your IBC at an ergonomic height for decanting
- Designed to prevent the operator from unnecessary strain when operating
- Steel Construction with a powdercoated finish
- V7910 Platform Height: 250–400mm
- V7911 Platform Height: 500–650mm
- Platform Size: 1250x1250mm
- Optional 100mm Castor Kit: 2 x Fixed, 2 x Swivel with brakes (Adds 160mm Height)

See page 271 for our IBC Spring Loaded Tilting Stand



Please Note; IBC Container isn't included

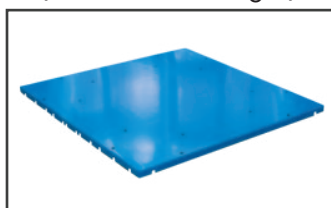

V7904 Steel Cap Base



V7911 with V7905 Castor Kit & V7906 Handle

Code	Description	Capacity (kg)	Unit Weight (kg)
V7910	IBC Tilting Stand with Short Adjustable Legs	2000	145
V7911	IBC Tilting Stand with Tall Adjustable Legs	2000	148
V7904	Steel Cap Base to suit V7910 & V7911		24.5
V7905	Castor Kit to suit V7910 & V7911	2000	11
V7906	Handle to suit V7910 & V7911		4.5

Heavy Duty Pallet Stand (with Adjustable legs & Turntable)

- The Heavy Duty Pallet Stand with Turntable is designed to rotate pallets, allowing for easier access to goods and materials on your pallet.
- Designed to prevent the operator from unnecessary strain when operating
- Steel Construction with a powdercoated finish
- V7912 Height: 275–425mm
- V7913 Height: 525–675mm
- Platform Size: 1250x1250mm
- Optional 100mm Castor Kit: 2 x Fixed, 2 x Swivel with brakes (Adds 160mm Height)



V7912 with V7905 Castor Kit

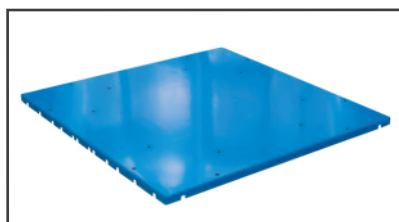

V7904 Steel Cap Base

Code	Description	Capacity (kg)	Unit Weight (kg)
V7912	Pallet Stand with Short Adjustable legs & Turntable	2000	160
V7913	Pallet Stand with Tall Adjustable legs & Turntable	2000	163
V7904	Steel Cap to suit V7912 & V7913		24.5
V7905	Castor Kit to suit V7912 & V7913	2000	11



Battery Electric Work Positioner

- A range of highly manoeuvrable, lightweight lifts, designed to take the strain out of any lifting job from ground level to over shoulder height
- Ideal for use in narrow aisles and confined spaces. Perfect for all applications from pharmaceutical to catering, from packing line to food processing
- Automatic electric overload protection system ensures safe operation
- Quick change attachment options available
- EN1757 compliant. CE marked
- Battery electric with built in charger that you can plug in anywhere
- Load Centre: 235mm
- 24v, 7.2Ah battery
- 75mm fixed rubber castors on front
- 125mm swivel rubber castors with brakes on rear
- Leg Height: 105mm

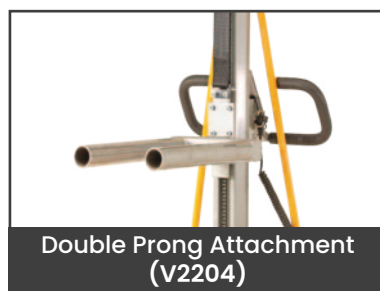
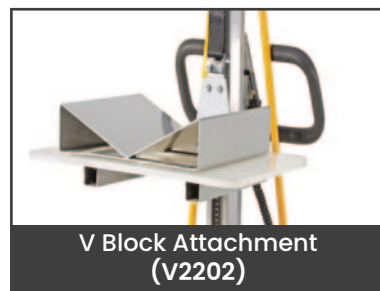

Code	Details	Load Capacity (kg)	Platform/ Attachment Size (mm)	Lifting Range (mm)	Overall Size LxWxH (mm)	Unit Weight (kg)
V2200	Work Positioner	100	470x660	130-1700	890x600x1990	62
V2201	Work Positioner	150	470x660	130-1500	890x600x1790	65
V2202	V Block Attachment - 400x400x80mm					
V2203	Roll Prong Attachment - 600x50mm					
V2204	Double Prong Attachment - 450x50mm (200mm between)					
V2205	Reel Handler Rotator Attachment - 430x90mm					



Stainless Steel Battery Electric Work Positioner

- These stainless steel lifters are ideal for the food and pharmaceutical industries where hose down is required.
- Automatic electric overload protection system ensures safe operation.
- EN1757 compliant. CE marked
- Battery electric with built in charger that you can plug in anywhere
- Battery: 24V, 12.0Ah
- Power: 24V, 200W
- Compatible with attachments pictured on previous page
- Load Centre: 235mm
- 75mm fixed rubber castors on front
- 125mm swivel rubber castors with brakes on rear
- Leg Height: 115mm
- S/S Grade: 304

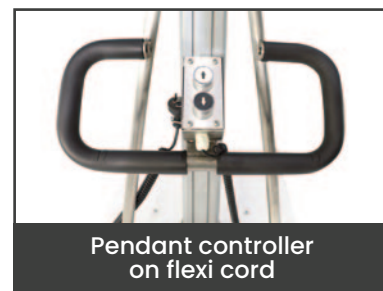

Pendant controller on flexi cord



Control Unit

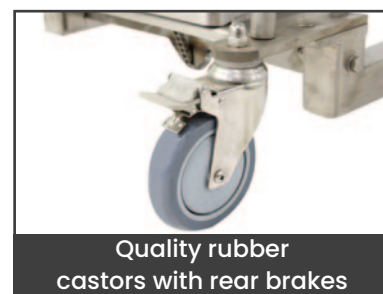

Quality rubber castors with rear brakes



Built in charger

Code	Load Capacity (kg)	Platform/ Attachment Size(mm)	Lifting Range (mm)	Overall Size LxWxH (mm)	Unit Weight (kg)
V2210	100	470x600	150-1760	890x600x1990	63
V2211	150	470x600	130-1560	890x600x1790	66



Battery Electric Platform Work Positioners

- A range of highly manoeuvrable, lightweight lifts, designed to take the strain out of any lifting job from ground level to over shoulder height
- Ideal for use in narrow aisles and confined spaces.
- Perfect for all applications from pharmaceutical to catering, from packing line to food processing
- Automatic electric overload protection system ensures safe operation
- Load Centre: 237mm
- Platform/ Attachment Size: 475x605mm
- Lifting/Lowering Speed: 55mm/s
- Steering Wheel: 100mm
- Battery: 12x2-10Ah
- Charger: DC-24V-2A



Control Unit



Code	Load Capacity (kg)	Lifting Range (mm)	Overall Size LxWxH (mm)	Unit Weight (kg)
V2190	100	130-1700	920x505x2160	65
V2191	150	130-1500	920x505x1950	65



Trailer Stabilising Jack Stand

- The Trailer Stabilising Jack is a heavy-duty support system designed to provide unrivalled stability and safety for trailers with a capacity of up to 45 tonnes.
- Engineered for maximum strength and durability, this jack is perfect for use in a wide range of industrial and commercial applications, such as loading docks, warehouses, and transportation hubs
- Top Diameter: 200mm
- 200mm Rubber Wheel



Code	Lifting Capacity (kg)	Static Capacity (kg)	Lifting Range (mm)	Overall Size LxWxH (mm)	Unit Weight (kg)
V2451	18,000	45,000	1000-1300	574x445x1300	40

10 Tonne Hydraulic Jack

- Great for jacking up containers & large equipment
- Removable pump hand lever
- The housing rotates 360 degrees

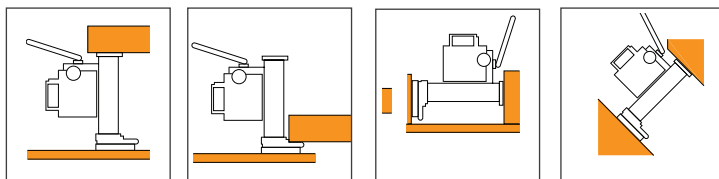

Code	Load Capacity (kg)	Lifting Range of Foot (mm)	Lifting Range of Head (mm)	Maximum Lever Force (kg)	Unit Weight (kg)
V2450	10,000	30-230	420-650	40	35

Compact Ride-On Electric Materials Handling Tug

The Compact ride-on compact electric tug is the ultimate manual handling solution designed for goods transport for trolleys and anything that is difficult to push or pull around in the hospital, aged care and industrial warehouse environments.

The Materials Handling Electric Towing Tug is a ride-on unit that doesn't compromise its small size for a ride. Its compact size allows it to be effective in confined spaces, whilst being able to turn on its self. With a very low centre of gravity, the risk of tipping is greatly reduced. Its two front steer wheels create exceptional stability across many rough surfaces.

- Motor Voltage: 24 Volts
- Range: 30-60km



Watch a video of this in operation on our website here: www.verdex.com.au/VI505



Code	Push Capacity (kg)	Pull Capacity (kg)	Overall Size LxWxH (mm)	Wheel Base (mm)	Unit Weight (kg)
VI505	1200	1500	790x660x1340	620	115



1000kg Smart Tow Tug

Great for moving dollies, trolleys and roll cages throughout the warehouse, workshop or shopping centres etc. Compact design which makes it extremely manoeverable and easy to transport in vehicles.

- Travel Speed: up to 6km/h
- Programmable speed controller
- Battery: 24v, 18Ah & DC 24v, 300w
- Motor: DC 24v, 300w
- Rear Wheels Solid: 250mm
- Front Wheels Poly: 75mm
- Handle Height: 750-1050mm (adjustable)
- Turning Radius: 475mm



Attachments pictured are supplied as standard with the Tow Tug



Watch a video of this in operation on our website here: www.verdex.com.au/V1500



Code	Traction Capacity (kg)	Width (mm)	Overall Size LxH (mm)	Unit Weight (kg)
V1500	1000	465	810x490	65

You May Also Like



Furniture Mover Set - See page 62

Manual Fork/Platform Stacker

- Foot pump hydraulic lift
- Comes with a removable platform and has 2 adjustable fork tines under platform for lifting skids and pallets
- Polyurethane castors - 2 x fixed, 2 x swivel with brakes
- Powder coated Finish



Adjustable fork tines for lifting skids and pallets



Watch a video of this in operation on our website here: www.verdex.com.au/v2230



Code	Load Capacity (kg)	Rear Castors (mm)	Front Castors (mm)	Platform Size (mm)	Fork Length (mm)	Lifting Range (mm)	Overall Size LxWxH (mm)	Unit Weight (kg)
V2230	400	125	75	660x580	650	75-1500	1040x590x1710	85

Electric Fork/Platform Stacker

- Electric hydraulic lift
- Battery: 12v 80Ah
- Comes with a removable platform
- 2 adjustable fork tines under platform for lifting skids and pallets
- Polyurethane castors - 2 x fixed, 2 x swivel with brakes
- Load Capacity: 400kg
- Rear Castors: 125mm
- Front Castors: 75mm



Adjustable fork tines for lifting skids and pallets



Watch a video of this in operation on our website here: www.verdex.com.au/v2231



V2231S



V2231

Code	Details	Platform Size (mm)	Fork Length (mm)	Lifting Range (mm)	Overall Size LxWxH (mm)	Unit Weight (kg)
V2231	Electric Stacker	660x580	650	80-1500	1040x590x1710	120
V2231S	Stainelss Steel Electric Stacker	660x580	650	80-1500	1040x590x1710	120



Aluminium Hand Stacker

- These aluminium lifters are great for assisting in the lifting, positioning and installation of goods up to 2500mm in height
- Manual hand winch control with automatic braking action
- Foot pedal brake
- Fits through standard doorways
- Quick set up - requires no tools
- Legs are straddle with quick adjustment
- Internal Adjustable Leg Dimensions: 570-940mm
- External Adjustable Leg Dimensions: 750-1120mm



Code	Load Capacity (kg)	Rear Castors (mm)	Front Castors (mm)	Platform Length (mm)	Load Centre (mm)	Lifting Range (mm)	Overall Size LxWxH (mm)	Unit Weight (kg)
V2250	180	200	50	570	254	50-2500	1100x736x1700	66

Aluminium Lift Assist Device

- These aluminium lifters are great for assisting in the lifting, positioning and installation of goods at height.
- Ideal for lifting items into ceiling spaces or handling machine parts at height.
- Folds for easy storage and transport.
- Manual hand winch control with automatic braking action
- Fits through standard doorways.
- Quick set up - requires no tools.
- Legs fold up for easy storage.
- Arm Length: 800mm
- Load Capacity at a 400mm load centre: 350kg
- Load Capacity at a 1000mm load centre: 150kg



Watch a video of this in operation on our website here: www.verdex.com.au/v2241



Arm Length (mm)	Ground Clearance (mm)	Operating Length (mm)	Front Castors (mm)	Rear Castors (mm)
800	50	1880	100	125

Code	Min. Height (mm)	Max Height (mm)	Folded Size LxWxH (mm)	Unit Weight (kg)
V2241	150	5000	870x730x2000	145



120KG Fork/Platform Trolley

- Robust, light weight steel construction platform lift trolley which is ideal for lifting heavy items to a work bench level for working on
- The platform is removable and has 2 fork tines which are adjustable under platform for lifting small skids

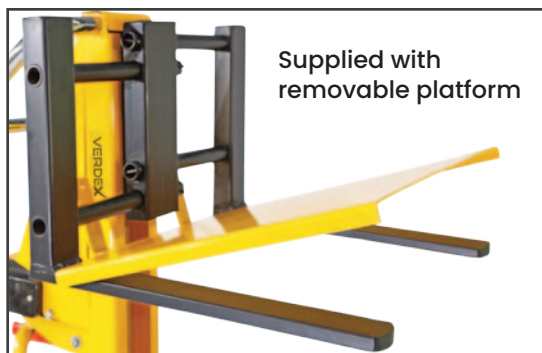

Supplied with removable platform



Code	Load Capacity (kg)	Rear Castors (mm)	Front Castors (mm)	Platform Size (mm)	Fork Size (mm)	Lifting Range (mm)	Overall Size LxWxH (mm)	Unit Weight (kg)
V2255	120	200	50	500x420	50x420	95-1050	700x460x137	39

Platform and Fork Lift Trolley

- The ideal trolley for lifting loads up to 150kg with ease
- Complies to relevant Australian Standards
- Swappable accessories for handling of different loads
- Forks for lifting small pallets and skids
- Platform for general lifting
- Patented silent winch which locks the load at any height
- Steel cable which runs inside the mast to prevent pinching
- Puncture proof rear wheels
- Made from aluminium
- Load Capacity (with forks): 150kg
- Load Capacity (with platform only): 120kg
- Platform Dimensions (DxW): 360x420mm
- Fork Dimensions (WxL) : 50x460mm



Watch a video of this in operation on our website here: www.verdex.com.au/V2265



Folded view



V2265



Image shown with optional fork kit (V2266)

Code	Details	Lift Height (mm)	Folded Size LxWxH (mm)	Overall Size LxWxH (mm)	Unit Weight (kg)
V2265	Platform Lift Trolley	1030	300x500x1320	710x530x1320	27
V2266	Fork Kit to suit V2265				



Heavy Duty Manual Fork Stackers

- These manual fork stackers are a very heavy duty construction and are an economical alternative to forklifts
- Manual hydraulic lift via pallet truck style handle or foot pedal
- Straddle leg model for use with standard 1170mm Australian pallets
- Standard leg model for use on Euro pallets and small skids
- Lockable rear wheels are standard on all models
- Front Castors: 80mm
- Rear Castors: 150mm

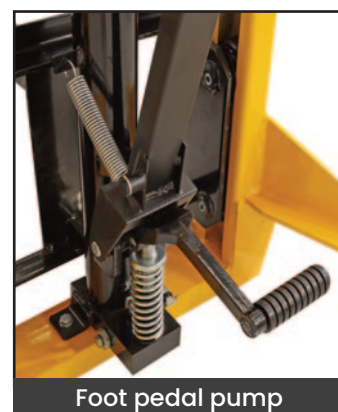

Watch a video of this in operation on our website here: www.verdex.com.au/V2280



Code	Details	Load Capacity (kg)	Lifting Range (mm)	Overall Width of Tines (mm)	Overall Size LxWxH (mm)	Unit Weight (kg)
V2280	Standard Leg Fork Stacker	500	90-1600	200-745	1640x805x2000	160
V2281	Straddle Leg Fork Stacker	500	70-1600	200-950	1600x1500x2000	225
V2282	Standard Leg Fork Stacker	1000	90-1600	200-700	1640x1000x2085	250
V2283	Straddle Leg Fork Stacker	1000	70-1600	200-950	1560x1450x2050	295



Pallet Turntable Disc

- The Pallet Turntable Disc is designed specifically so that pallets can be placed on or removed from the turntable using only a hand pallet truck
- Lifting lug screws into the centre of the disc and makes transportation of the unit easy.
- Disc Diameter: 1105mm

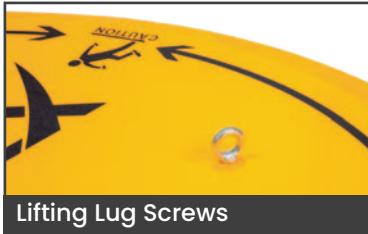

Lifting Lug Screws



Code	Load Capacity (kg)	Overall Size HxD (mm)	Unit Weight (kg)
V2145	2000	25x1235	120

Pallet Rotator Ring

- The rotator ring is popular due to its light weight and easy maneuverability.
- It can be moved easily by one person.
- 16 roller bearings to ensure smooth rolling for heavy loads



Suits Pallet Lift Tables



Designed for loading and unloading pallets

Code	Load Capacity (kg)	Overall Size WxH (mm)	Unit Weight (kg)
V2140	1000	1000x65	36



The Edge - Electric Pallet Truck

- The economical option for an electric pallet truck - avoid the strain of manually pushing a pallet standard pallet truck.
- Capacity up to 1500 kg and ability to overcome ramps up to 4/16% (loaded/unloaded) makes the truck suitable for work in loading docks and on delivery operations in different conditions
- The battery for this unit has a 3-6 hour battery life.
- Load Capacity: 1500kgs
- Min Fork Height: 85mm
- Lowered Height: 80mm
- Wheel Type: Polyurethane
- Travel Speed (unloaded): 5.8km/h
- Electric Brake
- Battery: 24V 20Ah
- Brushless AC motor
- Emergency stop button



Capacity up to **1500kg** and ability to overcome ramps up to **4/16%** (loaded/unloaded) makes the truck suitable for work in loading docks and on delivery operations in different conditions



Removable Lithium Battery



Pin can be set so only selected personnel can use the unit



Handle is supported by an air spring for smooth vertical return



Watch a video of this in operation on our website here: www.verdex.com.au/v2388



Code	Details	Load Capacity (kg)	Tine Size (mm)	Length of Tines (mm)	Overall Size LxW (mm)	Unit Weight (kg)
V2388	The Edge (540mm Wide)	1500	47x160x1150	1185	1530x540	123
V2385	The Edge (685mm Wide)	1500	47x160x1150	1185	1530x685	126
V2386	The Edge - Additional Battery 24V/20Ah					
V2387	Extra Battery Charger					4.6



2500KG Industrial Pallet Trucks

- All our pallet trucks come with a maintenance free pump. This means they are all made using high quality parts and German seal kits and are fitted with long life rollers and steering wheels.
- These safety yellow powder coated trucks are available in standard size 685mm wide, narrow pallet size 520mm and small skid size 450mm wide
- Steering Wheel Size: 50x180mm
- Rear steering wheels and fixed front castors



Code	Details	Load Capacity (kg)	Tine Size (mm)	Fork Length (mm)	Width (mm)	Overall Length (mm)	Lifting Range (mm)	Unit Weight (kg)
V2322	Standard Size - Poly Wheels	2500	50x160	1150	685	1550	85-190	70
V2323	Standard Size - Nylon Wheels	2500	50x160	1150	685	1550	85-190	67
V2326	Euro Size Pallet Truck - Poly Wheels	2500	50x160	1150	520	1550	85-190	60
V2325	Small Skid Size - Poly Wheels	2500	50x160	1150	450	1550	85-190	66

Low Profile Pallet Truck

- Easy access into low skids and pallets.
- Great for unloading containers with low import type pallets with a low clearance of only 51mm.
- Powder coated safety yellow
- Steering Wheel Size: 50x180mm
- Comes standard with nylon wheels, however polyurethane available on request
- Tine Size (HxW): 470x160mm
- Min Fork Height: 51mm



Watch a video of this in operation on our website here: www.verdex.com.au/v2330



Code	Details	Load Capacity (kg)	Fork Length (mm)	Width (mm)	Overall Length (mm)	Unit Weight (kg)
V2330	Low Profile Pallet Truck - Nylon Wheels	1500	1120	685	1550	80
V2329	Low Profile Pallet Truck - Polyurethane Wheels	1500	1120	685	1550	80



Super-Low Profile Pallet Truck

- Easy access into low skids and pallets.
- Great for unloading containers with low import type pallets with a super low clearance of only 35mm.
- Powder coated safety yellow
- Steering Wheel Size: 50x160mm
- Polyurethane rear wheels and steel rollers as front wheels to achieve an extremely low clearance



Watch a video of this in operation on our website here: www.verdex.com.au/V2331



Code	Load Capacity (kg)	Tine Size (mm)	Length (mm)	Width (mm)	Lifting Range (mm)	Unit Weight (kg)
V2331	1000	30x160	1120	520	35-91	100

Extra Long 2000KG Pallet Trucks

- These extra long pallet trucks are extremely useful for extra deep pallets
- Available in 1800 and 2500mm
- Also can be used to pickup two pallets in one lift.
- Tine Size: 60x160mm
- Steering Wheel Size: 50x200mm
- Powdercoated safety yellow
- Polyurethane wheels as standard however nylon wheels can be ordered if required



Watch a video of this in operation on our website here: www.verdex.com.au/V2345



Code	Details	Load Capacity (kg)	Tine Size (mm)	Length (mm)	Width (mm)	Min. Fork Height (mm)	Unit Weight (kg)
V2345	Extra Long Pallet Truck	2000	60x160	1800	520	85	100
V2346	Extra Long Pallet Truck	2000	60x160	1800	685	85	110
V2347	Extra Long Pallet Truck	2000	60x160	2500	685	85	285



2000kg Galvanised Pallet Trucks

- These galvanised pallet trucks are available in both standard size 680mm wide and Euro pallet size 520mm
- Ideal for the food, chemical and pharmaceutical industry or outdoor use
- Steering Wheel Size: 50x200mm
- Nylon wheels
- Tine Size: 60x160mm



Watch a video of this in operation on our website here: www.verdex.com.au/V2335



Code	Details	Load Capacity (kg)	Length (mm)	Width (mm)	Min. Fork Height (mm)	Unit Weight (kg)
V2335	Galvanised Pallet Truck (Standard Size)	2000	1120	685	85	67
V2336	Galvanised Pallet Truck (Euro Size)	2000	1150	520	85	65

Stainless Steel Pallet Trucks

- Ideal for the food, chemical and pharmaceutical industry or where corrosive acids are used.
- The front wheels are fully enclosed which is required for clean rooms and food environments.
- Grade of Stainless: 316
- Tine Size: 60x160mm
- Steering Wheel Size: 50x200mm
- Nylon wheels



Watch a video of this in operation on our website here: www.verdex.com.au/V2340



Code	Details	Load Capacity (kg)	Length (mm)	Width (mm)	Min. Fork Height (mm)	Unit Weight (kg)
V2340	Stainless Steel Pallet Truck (Standard Size)	2000	1150	685	85	75
V2341	Stainless Steel Pallet Truck (Euro Size)	2000	1150	520	85	72



2000KG Pallet Trucks With Load Scales

- Our scale pallet trucks are extremely reliable and highly accurate in measuring your pallet weight.
- This fork truck has a totalising function which adds up multiple pallet weights giving the total weight per shipment or order.
- The weighing unit uses four AA batteries which give approx 4200 weighting actions
- The unit gives a low battery warning and shuts off after 3 minutes
- Optional scale printer unit available on request
- Scale Increments: 1kg
- Scale Functions: Zero correction, gross/net weight, total weight
- Nylon Wheels
- Steering Wheel Size: 50x180mm
- Tine Size: 50x182mm



Watch a video of this in operation on our website here: www.verdex.com.au/V2350



Code	Details	Load Capacity (kg)	Fork Length (mm)	Width (mm)	Min. Fork Height (mm)	Overall Size LxW (mm)	Unit Weight (kg)
V2350	Pallet Truck With Load Scales	2000	1150	690	76	1650x690	113
V2350N	Narrow Pallet Truck With Load Scales	2000	1150	690	76	1650x555	113

Stainless Steel 2000kg Pallet Truck With Load Scales

- These stainless steel pallet trucks are ideal for applications in the food and medical industries or areas where corrosive acids are used.
- Fully stainless steel - 316 grade
- Scale Increments: 2kg
- Scale Functions: Zero correction, gross/net weight, total weight
- Steering Wheel Size: 50x180mm
- Nylon Wheels



Code	Load Capacity (kg)	Tine Size (mm)	Length (mm)	Width (mm)	Min. Fork Height (mm)	Unit Weight (kg)
V2355	2000	50x182	1150	690	85	138



5 Tonne Heavy Duty Pallet Truck

- These extra heavy duty pallet trucks can be used to move heavy machinery and come with a towing hook for pulling if required
- Steering Wheel Size: 50x200mm
- Tine Size: 50x160mm
- Powder coated safety yellow
- Steel roller wheel



Heavy duty steel rollers



Watch a video of this in operation on our website here: www.verdex.com.au/V2365



Code	Load Capacity (kg)	Length (mm)	Width (mm)	Lifting Range (mm)	Unit Weight (kg)
V2365	5000	1150	680	90-200	130

Rough Terrain Pallet Truck

This rough terrain pallet truck is great for applications such as timber yards, brick yards and hard stand areas where the ground is gravel or rough.

- Large pneumatic wheels
- Adjustable Fork Width: 228-735mm
- Width Inside Front Wheels: 1230mm
- Front Wheel Size: 550x132mm (Dia x Width)
- Rear Wheel Size: 265x80mm (Dia x Width)
- Turning Radius: 1500mm
- Axle Distance between Front and Rear Wheels: 973mm



Code	Load Capacity (kg)	Load Centre (mm)	Tine Size (mm)	Fork Length (mm)	Lifting Range (mm)	Overall Size LxWxH (mm)	Unit Weight (kg)
V2360	1200	450	100x50	860	63-233	1375x1605x1200	245



Manual Hi-Lift Pallet Trucks

- Great for lifting skids and pallets with no bottom rail
- Extremely easy to pump and light weight
- Quick-lift as standard with automatic transfer to normal lifting loads over 150kg
- Automatic descending speed control, regardless of load
- Front support legs and adjustable stabilisers ensure maximum stability
- Heavy duty design
- Conforms to EN 1757-4
- Not suitable for closed pallets with a bottom rail

Stainless Steel option is available as a special order



Code	Load Capacity (kg)	Length (mm)	Width (mm)	Lifting Range (mm)	Tine Size (mm)	Lifting Range (mm)	Unit Weight (kg)
V2371	1000	1100	520	85-800	50x160	85-800	118
V2370	1000	1150	680	85-800	50x160	85-800	125

Electric Hi-Lift Pallet Trucks

- Great for lifting skids and pallets with no bottom rail
- Quick-lift as standard with automatic transfer to normal lifting loads over 150kg
- Automatic descending speed control, regardless of load
- Front support legs and adjustable stabilisers ensure maximum stability
- Heavy duty design
- Conforms to EN 1757-4
- Not suitable for closed pallets with a bottom rail
- Battery: 12v, 54Ah

Stainless Steel option is available as a special order



Code	Load Capacity (kg)	Length (mm)	Width (mm)	Lifting Range (mm)	Tine Size (mm)	Lifting Range (mm)	Unit Weight (kg)
V2373	1500	1100	520	85-800	50x160	85-800	150
V2372	1500	1150	680	85-800	50x160	85-800	160



Fork Extension Slippers / Tines (Galvanised)

- Fork slippers extend the versatility of your lift truck
- The safe working load (SWL) is measured per pair at 600mm load centre
- Slippers conform to relevant Australian Standards
- Designed and manufactured in accordance with AS2359.15 and other relevant Australian standard which requires the slippers used for general usage to be not longer than 167% of the supporting tine's length.

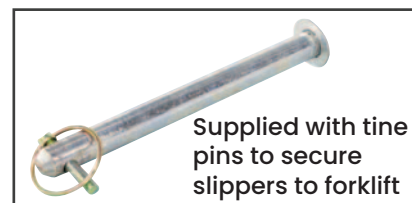

Code	*SWL (kg)	Length (mm)	Internal Tine Size (mm)	External Tine Size (mm)	HCG (mm)	Weight Per Pair (kg)
V2405	*4500	1780	138x55	150x67	845	66
V2406	*4500	2400	138x55	150x67	1154	88
V2407	*8500	1800	170x76	185x92	830	133
V2408	*8500	2400	170x76	185x92	1154	177
V2409	*8500	3000	170x76	185x92	1454	221

*SWL shown here is the maximum however it varies depending on forklift capacity - Refer to load capacity plate on your forklift

Slip-On Roll Forklift Prong

Slip-on Roll Prong suitable for fabric, cable, carpet and coil products. These attachments quickly adapt to almost any forklift and require only the connection of a safety chain to prevent unintentional disengagement.

- Prongs are manufactured from solid steel
- Finish: Zinc Plated
- The safe working load (SWL) is measured at 1400mm load centre
- SWL: 510kg
- Prong Overall Length: 3940mm



Code	Prong Diameter (mm)	Length (mm)	Fork Pocket Size (mm)	Fork Centres (mm)	HCG (mm)	Unit Weight (kg)
V2415	70	2800	190x65	345	1553	163



Forklift Drum Cable Slippers

- These attachments are designed to fit onto the forks of a forklift, allowing the forklift to safely lift and move cable drums without damaging the drums or the forklift.
- Designed to suit spindle up to 50 - 80mm diameter
- Supplied with 1200 long x 48mm diameter spindle
- Powder coated finish
- Designed and fabricated strictly in accordance with relevant Australian Standards
- AS/NZS 1554.1: 2011 Structural Steel Welding (*see online for more details*)



Code	Capacity (kg)	Length (mm)	Max. Tine Size (mm)	VCG (mm)	HCG (mm)	Unit Weight (kg)
V2417	1000	1300	100x45	48	734	34
V2418	1500	1300	130x50	50	684	50
V2419	2000	1300	155x55	50	664	62

Cable Drum Stirrups

- The V2416 Cable Drum Stirrups is an affordable solution to lift and transport cable drums by forklift.
- Cradle to suit up to 50mm diameter spindles
- Supplied with a 48mm diameter x 1200mm long spindle
- Locking bolt safely secures the drum stirrup in position on forks
- Supplied as a pair
- Enamel paint finish



Please note; Cable Drum isn't supplied with Stirrups

Code	Working Load Limit (kg)	Max. Fork Arm Width (mm)	Fork Pocket Size (mm)	Unit Weight (kg)
V2416	2000	130	150x45	30/pair

Fork Spreader with Load Guard

The V2476 fork spreader evenly distributes the load over the length of the attachment with a load back guard to help secure high loads. The slip-on attachment is secured to the lift truck by a safety chain.

- Capacity: 3000kg at 600mm Load Centre
- Load Guard Height: 560mm



Code	Spreader Width (mm)	Spreader Depth (mm)	Fork Pocket Size (mm)	Fork Pocket Centres (mm)	Tine Size LxWxH (mm)	Unit Weight (kg)
V2476	3000	1200	160x60	872	1050x100x45	255

2.5 Tonne Forklift Tine Hook

- Converts forklift into a mobile crane in seconds
- Adjustable mounting position along the length of the fork
- Secured to forks by thumb screw
- Swivel hook includes safety latch
- Powder coated yellow



Image shown with (Lift Table V2110)

Code	Load Capacity (kg)	Fork Pocket Size LxW (mm)	Unit Weight (kg)
V2440	2500	150x60	25



Bulk Bag Jib (3 Tonne)

- This Bulk Bag Jib is designed to safely handle and move bulk bags by both forklift and overhead crane.
- Versatile design allows easy transfer from forklift to crane and vice versa.
- Fitted with four safety swivel hooks for securing the bulk bag straps at 800mm centres
- Allows for one handed connection and disconnection of straps
- Certified to relevant Australian Standards
- Zinc finish

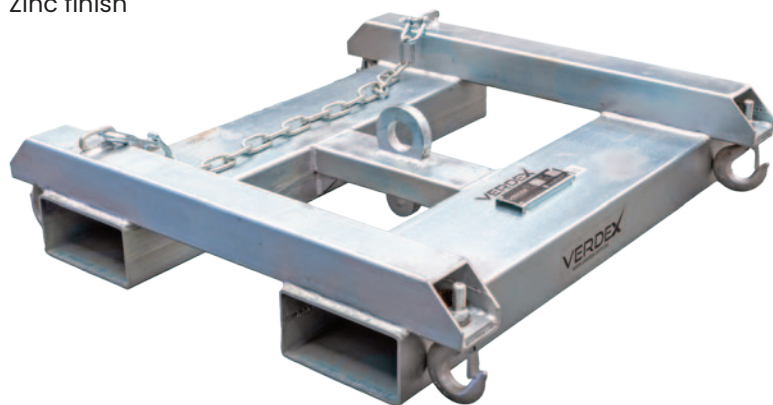

Code	Safe Working Load (kg)	Load Centre (mm)	Jib Size LxW (mm)	Fork Pocket Size (mm)	Fork Pocket Centres (mm)	Hook Centres (mm)	Unit Weight (kg)
V2438	3000	450	900x860	185x85	500	800	85

Bulk Bag Lifter

- Designed for lifting bulk bags by overhead crane
- Enamel paint finish
- Designed with 4 lifting loops for easy positioning of bulk bag
- Suits 80cm standard bulk bags



Code	Safe Working Load (kg)	Hook Centre 'A' (mm)	Hook Centre 'B' (mm)	Unit Weight (kg)
V2537	2000	800	1170	45



Crane / Forklift Spreader Beam

- Using a Crane, loads can be lifted via the centre single hook point (as a 'Lifting Beam'), or end lifted using a 2 leg Chain Sling (as a 'Spreader Beam').
- If lifting by forklift, the 600mm long slipper pockets allow for fast and safe connection to the truck.
- The Spreader Beam load connection points are adjustable to 3 positions by moving the extendable arms each end.
- Both extendable arms are locked into position via safety pins.
- The unit is supplied standard with a safety swivel hook each end.
- Zinc plated arms with the main body painted in 'safety orange'.



Rated Capacity When used as	Fully Retracted (LC @ 2405mm)	Middle Position (LC @ 3165mm)	Fully Extended (LC @ 3925 mm)
Forklift Attachment	3500kg	1500kg	750kg
Lifting Beam	4500kg	2500kg	1300kg
Spreader Beam	9000kg	7200kg	5600kg

Code	F/Lift HCG (mm)	Rated Capacity (kg)	Fork Pocket Size (mm)	Fork Centres (mm)	Overall Size (mm)	Unit Weight (kg)
V2470	2405	9000	190x65	900	2600x600x410	172

Heavy Duty Pallet Hook (4500kg)

A heavy duty 4.5 tonne capacity pallet hook for loads up to 4500kg. Fully adjustable tines makes this unit extremely versatile. Load balancing is carried out by positioning the lifting ring to suit the Centre of Gravity of the load.

Load balancing is via the moveable lifting ring. The Pallet Hook has been designed & certified in accordance with relevant Australian Standards

- Clearance is the distance between tines and head
- Finish: Enamel painted



Code	SWL (kg)	Load Centre (mm)	Tine Size (mm)	Clearance Between Tines and Head (mm)	Unit Weight (kg)
V2460	4500	600	125x50x1070	1405	456



Automatic Pallet Hook (2000kg)

The automatic pallet hook, type V2462, is self-levelling for ease of operation. An internal spring mechanism ensures the lifting eye is in the correct position to keep the tines horizontal, eliminating the need to reposition the lifting ring. Enclosed frame members protect the operator from moving parts. The Pallet Hook has been designed & certified in accordance with relevant Australian Standards

- Clearance is the minimum distance between tines and head
- Finish: Zinc plated



Code	SWL (kg)	Load Centre (mm)	Adjustable Tine Size (mm)	Clearance (mm)	Unit Weight (kg)
V2462	250-2000	600	100x45x1055	1355	196

Adjustable Pallet Hook (2200kg)

The V2461 Pallet Hook features variable body height and adjustable tine width, making this versatile attachment ideal for the transport and construction industry.

Load balancing is via the moveable lifting ring. The Pallet Hook has been designed & certified in accordance with relevant Australian Standards

- Adjustable Clearance is the distance between tines and head
- Finish: Zinc plated

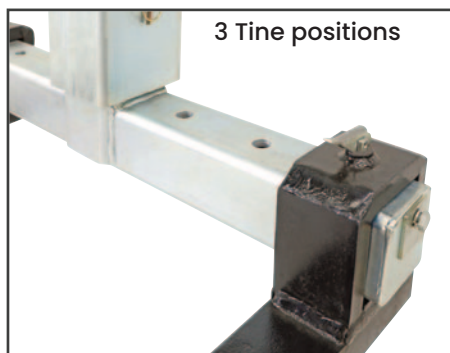

Code	SWL (kg)	Load Centre (mm)	Tine Size (mm)	Adjustable Clearance (mm)	Unit Weight (kg)
V2461	2200	600	100x45x1055	1005-1605	215

4.5 Tonne Telescopic Short Jib

- This 4500kg telescopic short fixed jib is designed as an affordable general purpose jib which is great for confined spaces and has a 1.9 metre reach when fully extended.
- Finish: Zinc plated
- 4 jib positions
- Load Centre: 670mm

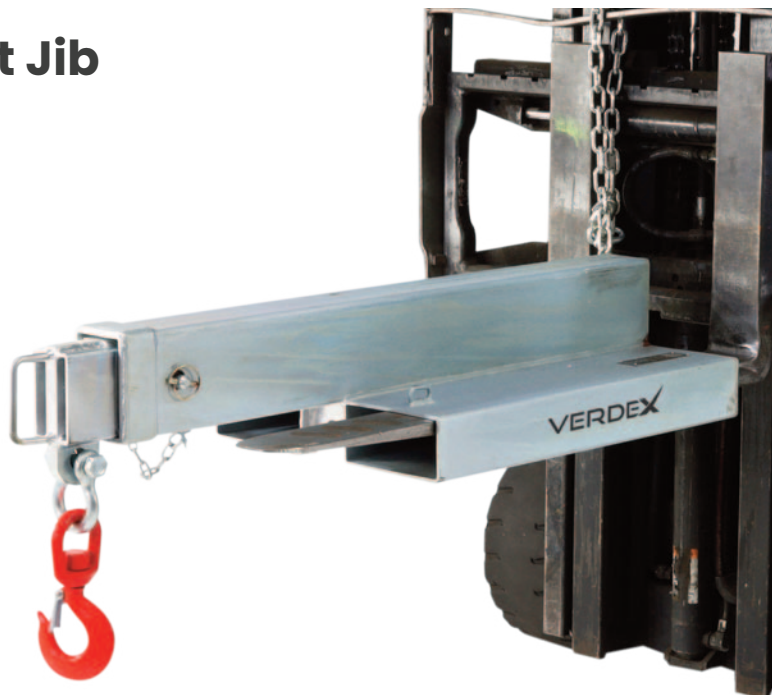

SAFE WORKING LOADS (SWL) PER POSITION				
POSITION	1	2	3	4
EXTENSION (mm)	670	1165	1545	1925
SWL (kg)	4500	2900	1300	750

Code	SWL (kg)	HCG (mm)	Jib Length When Closed (mm)	Jib Length When Extended (mm)	Fork Pocket Size (mm)	Fork Pocket Centres (mm)	Unit Weight (kg)
V2420	4500	542	1250	1900	185x65	290	95

4.5 Tonne Telescopic Long Jib

- This 4500kg tonne telescopic jib is a general purpose jib which is great for reaching across pits and areas where the forklift cant drive up to as it has a 3.5 metre reach when fully extended.
- Safe Working Load: 4500kg
- Load Centre: 870mm
- HGC: 836mm
- Finish: Zinc plated
- 6 jib positions
- Overall Dimensions at position 1 (LxWxH): 2040x490x250mm



SAFE WORKING LOADS (SWL) PER POSITION						
POSITION	1	2	3	4	5	6
EXTENSION (mm)	870	1945	2325	2705	3085	3465
SWL (kg)	4500	1300	750	560	380	200

Code	SWL (kg)	Jib Length When Closed (mm)	Jib Length When Extended (mm)	Fork Pocket Size (mm)	Fork Pocket Centres (mm)	Unit Weight (kg)
V2421	4500	2000	3500	185x65	290	140



2.0 Tonne Hook & Tow Jib Attachment

This 2000kg hook & tow jib is suitable for most forklifts and is a simple slip-on attachment with safety chain and swivel hook as pictured.

- Safe Working Load: 2000kg at 1160mm load centre
- Finish: Zinc plated
- Maximum weight on towball can't exceed 500kg
- Hook jib has 2 lifting positions
- Overall Dimensions at position 1:
(LxWxH): 1410x420x140mm

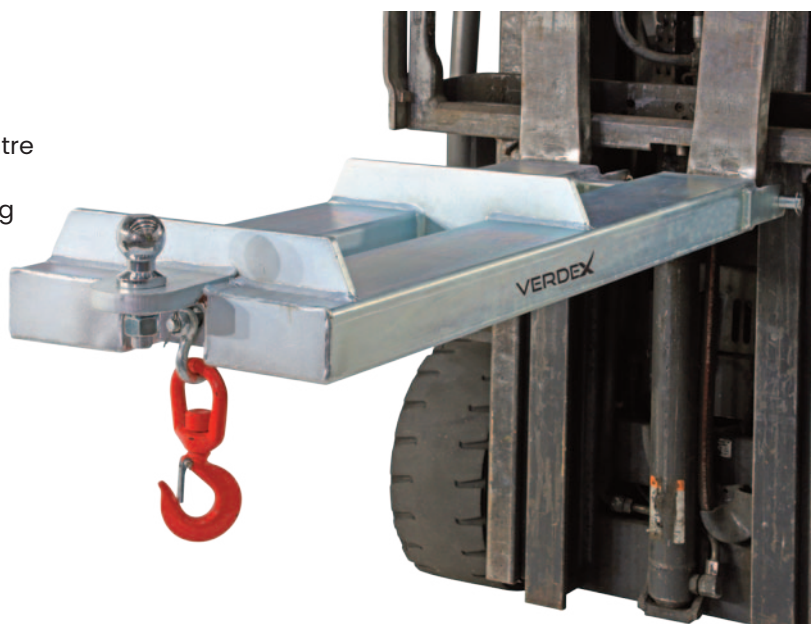
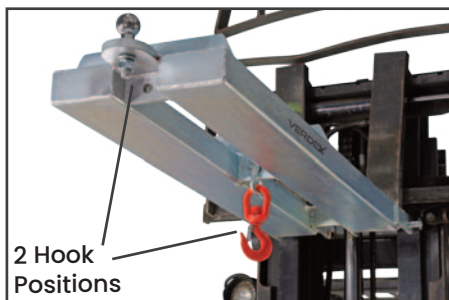

Code	Details	SWL (kg)	Fork Pocket Size (mm)	Fork Pocket Centres (mm)	Fork Pocket Length (mm)	Unit Weight (kg)
V2429	Hook Jib - 2.0 Tonne Capacity	2000	140x65	250	1220	45
V2430	Hook & Tow Jib - 2.0 Tonne Capacity	2000	140x65	250	1220	45

4.5 Tonne Long Tilting Jib

This 4500kg long tilting jib is the most versatile jib in our range and allows for additional height of up to 2.23 metres.

- SWL chart is show in table
- Finish: Zinc plated
- 6 jib positions
- Overall Dimensions when closed
(LxWxH): 2100x520x650mm
- HGC: 735mm
- Load Centre: 770mm

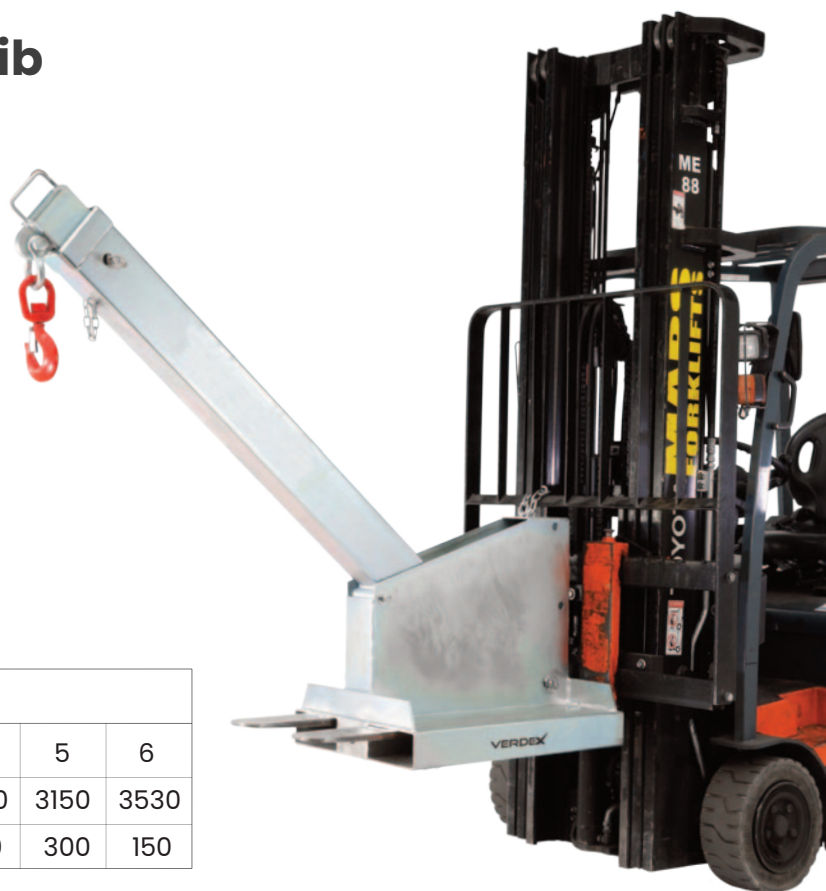

SAFE WORKING LOADS (SWL) PER POSITION

POSITION	1	2	3	4	5	6
EXTENSION (mm)	770	2010	2390	2770	3150	3530
SWL (kg)	4500	1100	630	470	300	150

Code	SWL (kg)	Jib Length When Closed (mm)	Jib Length When Extended (mm)	Fork Pocket Size (mm)	Fork Pocket Centres (mm)	Unit Weight (kg)
V2422	4500	2100	3530	185x65	322	190

Deluxe Drum Cradle

- Heavy duty drum cradle with retractable handles for use on 210 litre steel drums
- Great for moving drums around the site and to lay drums into the side position.
- Durable zinc plated finish
- Single person operation
- Wheel Type: Nylon



Code	Load Capacity (kg)	Length (mm)	Width (mm)	Horizontal Height (mm)	Unit Weight (kg)
V5000	300	1000	370	450	14.5

Steel Drum Palletiser

- Loads and unloads drums to and from the corner of a pallet
- Suit steel drums with rim tops
- Locking handle holds weight of drum for easy transport
- Wheel Type: Polyurethane



Code	Load Capacity (kg)	Overall Size LxWxH (mm)	Unit Weight (kg)
V5020	365	800x1220x1160	85

Low Profile Drum Trolley

- This drum trolley has a built in handle which is used for tilting the drum back to push the trolley under.
- Handle has built in bung remover and seal remover
- Wheel Size: 150x50mm (front), 75x32mm (rear)
- Raises drum 25mm



Code	Load Capacity (kg)	Overall Size HxDxW (mm)	Unit Weight (kg)
V5045	500	950x570x750	17



Steel Drum Carrier / Rotator

- Remarkably versatile 210 litre Drum Carrier/Rotator Raises, transports, rotates, tilts and drains fully loaded drums
- Lockable in horizontal or vertical position
- Can be turned end over end to agitate contents
- 2 x 200mm roller bearing castors and 1 x 100mm swivel castor



Code	Load Capacity (kg)	Length (mm)	Height (mm)	Width (mm)	Clearance under drum while horizontal (mm)	Unit Weight (kg)
V5005	370	1250	1180	900	370	42

Plastic Drum Carrier / Rotator

- Remarkably versatile 210 litre Drum Carrier/Rotator Raises, transports, rotates, tilts and drains fully loaded plastic drums
- Lockable in horizontal or vertical position
- Can be turned end over end to agitate contents
- 200mm roller bearing castors and 100mm swivel castor
- Powder coated steel



Code	Load Capacity (kg)	Length (mm)	Height (mm)	Width (mm)	Clearance under drum while horizontal (mm)	Unit Weight (kg)
V5006	370	1250	1180	900	370	47

Steel & Plastic Drum Trolley

- This drum trolley suits both steel and plastic 210 litre drums
- Suits plastic drums with a top lip
- Hydraulic handle pump which provides smooth easy lifting



Watch a video of this in operation on our website here: www.verdex.com.au/v5015



Code	Load Capacity (kg)	Overall Size LxWxH (mm)	Minimum beak height (mm)	Maximum beak height (mm)	Unit Weight (kg)
V5015	250	820x800x1050	855	1160	42

Steel & Plastic Drum Trolley

- These drum trolleys are ideal for transporting both steel and plastic drums and are available in solid wheel and pneumatic wheels for rough and uneven ground
- This trolley is also self-standing which means the operator can leave without drums falling over
- Wheels: 400mm front, 75mm castors on the rear



V5026



V5025

Code	Details	Load Capacity (kg)	Overall Size LxWxH (mm)	Unit Weight (kg)
V5025	Steel/Plastic Drum Trolley (Solid Wheel)	450	750x700x1050	24
V5026	Steel/Plastic Drum Trolley (Pneumatic Wheel)	450	750x700x1050	28



Steel & Plastic Drum Lifter/Palletiser

- This drum trolley suits both steel and plastic 210 litre drums.
- Spring loaded clamp grabs the drum rib with no manual input
- The lifter has a brake to avoid rolling on sloped areas



Code	Load Capacity (kg)	Lifting Height (mm)	Length (mm)	Height (mm)	Width (mm)	Unit Weight (kg)
V5030	400	1070	1100	1830	910	100

Drum Palletiser Stackers

- These drum palletisers stackers are great for loading and unloading both plastic and steel drums onto pallets
- Can also be used to stack drums on top of another drum or to place on a truck or ute
- V5036 comes with a battery operated weighing scale which gives you an accurate measurement of the drums weight
- Powder coated Steel



Code	Details	Load Capacity (kg)	Max Lift Height (mm)	Leg Length (mm)	Overall Size LxWxH (mm)	Unit Weight (kg)
V5035	Drum Palletiser Stacker	450	1100	500	1140x950x1870	130
V5036	Drum Palletiser Stacker (with load scales)	450	1100	500	1150x950x1870	135

Hydraulic Drum Truck

- Easily transport steel drums with this drum truck
- Designed to streamline drum handling tasks, this drum truck offers unmatched convenience and versatility in industrial environments
- Pallet truck style design
- Powder coated steel
- Nylon wheels



Code	Load Capacity (kg)	Min Arm Height (mm)	Max Arm Height (mm)	Radius of Arm (mm)	Overall Size LxW (mm)	Unit Weight (kg)
V5040	365	270	390	270	1022x722	53

Drum Dollies

- Drum dollies are suitable for both steel and plastic drums and containers
- Powder coated and stainless steel options
- Heavy duty easy wheel castors
- 3 versions available
- Castor Size: 75mm



V5051



V5051 pictured with Drum



V5050



V5052

Code	Details	Load Capacity (kg)	Overall Size LxWxH (mm)	Inner Diameter (mm)	Outer Diameter (mm)	Unit Weight (kg)
V5050	Drum Dollie (Powder coated)	300	710x710x150	600	710	7.5
V5051	Drum Dollie (Stainless Steel)	300	710x710x150	600	710	7.5
V5052	Heavy Duty Drum Dollie (Powder coated)	500	630x630x150	615	630	9



Drum Tongs

- For lifting steel drums with an overhead crane or the fork tine hook
- To operate, set locking lever in locked open position
- Hooks automatically engage when lifted and disengage when the drum is put down
- Suitable for steel drums

Code	Load Capacity (kg)	Jaw Opening Distance (mm)	Unit Weight (kg)
V5055	500	910	8



100 & 110L Enviro Drum Hooks

- These Drum Hooks are designed for lifting 100 & 110L enviro drums.
- Crafted with precision and durability in mind, these hooks are essential tools for handling drums in various industrial & commercial settings.
- Hot dipped galvanised finish
- Working load Limit: 200kg

Code	Details	Overall Size LxWxH (mm)	Unit Weight (kg)
V5053	100L Enviro Drum Hook	390x40x215	1.6
V5054	110L Enviro Drum Hook	490x40x170	2



Hook Drum Lifter

- Suitable for both steel and plastic 210 litre drums
- Works on any drum that has a rim to grab onto
- Ideal for picking up a drum in the middle of a cluster without having to move any that are in front



Code	Load Capacity (kg)	Overall Size HxWxD (mm)	Unit Weight (kg)
V5056	500	215x711x711	13

Drum Sling Lifter

- This sling lifter is ideal for lifting drums and cylinders using an overhead crane or forklift lifting hook device
- Suits up to 210 litre drums
- Supplied with metal head ring

Code	Details	Sling Length (mm)	Unit Weight (kg)
V5057	Drum Sling Lifter - 500kg	1100	3
V5058	Drum Sling Lifter - 1000kg	1100	4



Forklift Geared Drum Rotator

- Converts your forklift into a drum handler
- Suitable for 210 litre steel and plastic drums
- Easily attached to most fork trucks
- Able to lift, raise and tilt loaded drums
- Finish: Painted safety yellow
- Drum Size: 570-600mm



Code	Load Capacity (kg)	Fork Pocket Size (mm)	Fork Pocket Centres (mm)	Unit Weight (kg)
V5065	300	150x55	825	60

Forklift Drum Rotator

- Converts your forklift into a drum handler
- Suitable for 210 litre steel drums
- Easily attached to most fork trucks
- Able to lift, raise and tilt loaded drums
- 3 metre pull chain from operators seat
- 30:1 gearing ratio
- Finish: Painted safety yellow



Code	Load Capacity (kg)	Fork Pocket Size (mm)	Drum Size dia. (mm)	Unit Weight (kg)
V5066	380	180x65	570-600	97



Drum Tipper / Dumper

- Fast and efficient solution to emptying 205 litre steel drums, ideally suited to waste and scrap products
- The drum is secured with the sturdy belly strap & locked in place with the over-centre catch & locking pin
- A rope draw chord is pulled from the driver's seat to dump the drum where required. A custom locking mechanism is fitted to prevent accidental release while driving over bumpy ground
- Rotational ability 180 degrees



Code	Working Load Limit (kg)	Load Centre (mm)	Fork Pocket Size (mm)	Fork Pocket Centres (mm)	Overall Size LxWxH (mm)	Unit Weight (kg)
V5069	500	1000	185x65	840	1400x1040x600	85

Galvanised Forklift Drum Grab

- Attaches quickly and easily to most fork trucks
- Heavy duty welded steel construction
- Lifts, transports and deposits steel drums without having to leave the drivers seat
- Finish: Galvanised
- Load Centre: 1340mm
- HCG: 824mm



Watch a video of this in operation on our website here: www.verdex.com.au/v5076

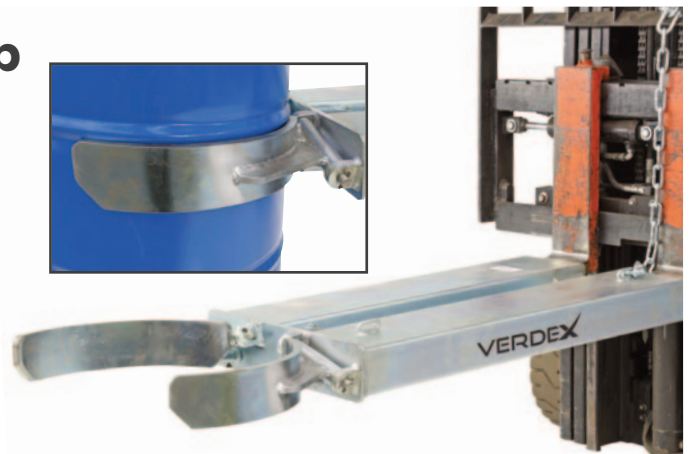

Code	Load Capacity (kg)	Fork Pocket Size (mm)	Fork Pocket Centres (mm)	Unit Weight (kg)
V5076	500	165x65	325	78



Forklift Drum Grab

- Attaches quickly and easily to most fork trucks
- Heavy duty welded steel construction
- Lifts, transports and deposits steel drums without having to leave the drivers seat
- Finish: Painted safety yellow

Code	Load Capacity (kg)	Fork Pocket Size (mm)	Fork Pocket Centres (mm)	Unit Weight (kg)
V5075	680	177x58	330	56



Parrot Beak Drum Lifters

- Suitable for both steel and plastic 210 litre drums
- Simple auto clamp operation, no need to leave the drivers seat
- Allows the operator to remove and place drums on pallets or bunds without having to leave the forklift seat
- Height adjustable for use with different drum shapes
- Available in single and double drum pickups
- Finish: Painted safety yellow



V5080



V5081



Watch a video of this in operation on our website here: www.verdex.com.au/v5080



Code	Details	Load Capacity per beak (kg)	Fork Pocket Size LxWxH (mm)	Fork Pocket Centres (mm)	Unit Weight (kg)
V5080	Parrot Beak Drum Lifter (single)	360	750x150x55	500	45
V5081	Parrot Beak Drum Lifter (double)	360	750x150x55	590	62

Galvanised Parrot Beak Drum Lifter

- Suitable for both steel and plastic 210 litre drums with a top lip
- Simple auto clamp operation - no need to leave the drivers seat
- Allows the operator to remove and place drums on pallets or bunds without having to leave the forklift seat
- Finish: Zinc plated
- HCG: 560mm
- VCG: 130mm



Code	Load Capacity (kg)	Load Centre (mm)	Fork Pocket Size (mm)	Fork Pocket Centres (mm)	Unit Weight (kg)
V5085	1000	1210	185x60	250	72



Drum Positioner

- Suitable for both steel and plastic 210 litre drums
- Can change drum position from vertical to horizontal & vice-versa
- Hinged tines automatically lock when lowered to the ground in horizontal position
- Suitable for loading drums onto transport vehicles
- Works great for loading & unloading drums off rack stands
- Can be operated without the driver having to leave the forklift seat



Watch a video of this in operation on our website here:
www.verdex.com.au/V5090



Code	Load Capacity (kg)	Prong Distance Apart (mm)	Fork Pocket Size (mm)	Fork Pocket Centres (mm)	Overall Size LxWxH (mm)	Unit Weight (kg)
V5090	400	575	150x60	420	1800x700x660	75

Fixed Prong Drum Positioner

- Suitable for both steel and plastic 210 litre drums
- Works great for loading and unloading drums off rack stands



Code	Load Capacity (kg)	Prong Distance Apart (mm)	Fork Pocket Size (mm)	Fork Pocket Centres (mm)	Overall Size LxWxH (mm)	Unit Weight (kg)
V5091	300	565	140x50	560	1360x715x120	42

Forklift Side Operated Drum Rotator (Chain Drive)

- Empties a standard 205 litre drums with minimal effort
- Suitable for drum rotation up to 3m above ground
- Rotation carried out via hand chain
- Belly strap and eccentric lock secures drum in position
- Locking pin prevents accidental release
- Slip-on attachment allows quick connection to a forklift
- Can be coupled with the Plastic Barrel Option
- Zinc finish
- Rotation: 360°

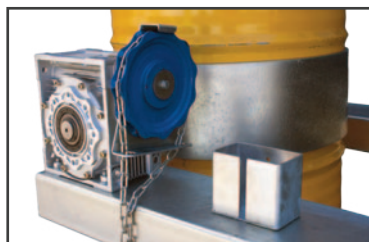

Code	Load Capacity (kg)	Load Centre (mm)	Fork Pocket Size (mm)	Fork Pocket Centres (mm)	Unit Weight (kg)
V5068	400	940	185x60	840	90



Side Shift Drum Palletiser

- The Side Shift Drum Palletiser is specially designed for moving drums and barrels from any position on a pallet.
- It uses a sliding side-shift arrangement allowing it to even be used for moving containers and drums placed in the centre of a pallet.
- The palletiser straddles the pallet and only requires access to one side, thus allowing pallets in confined areas to be kept against the wall even when unloading.
- When moving the drum onto another pallet, scales or the floor, the drum can also be moved to either side using the side-shift arrangement
- This unique design side shift drum palletiser can pickup drums from any position on the pallet, skid or bund -straddles beside and over the pallet
- Suitable for both steel and plastic drums
- The operator requires only 12kg of force on the handle to lift a 300kg drum



Watch a video of this in operation on our website here: www.verdex.com.au/V5160

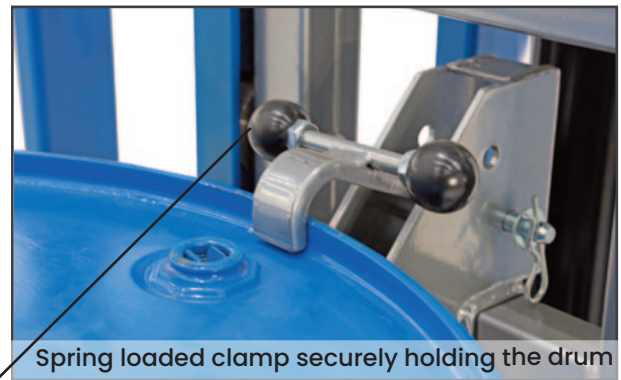

Spring loaded clamp securely holding the drum



Handle lever to lower drum



Foot pedal to raise drum



Code	Load Capacity (kg)	Ground / Pallet Clearance (mm)	Max Lift Height (mm)	Overall Size LxWxH (mm)	Unit Weight (kg)
V5160	350	350	575	920x1550x1520	168



POPULAR FORKLIFT ATTACHMENTS AND LIFTING EQUIPMENT



Cable Drum Stirrups
See Page 211



Forklift Tine Hook
See Page 212

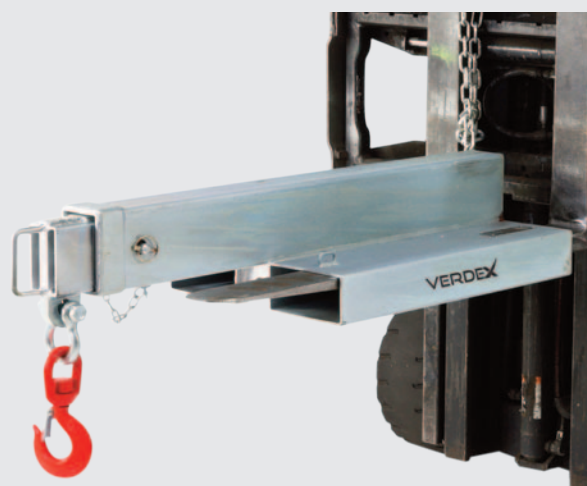

Telescopic Short Jib
See Page 216



Long Tilting Jib
See Page 217



Fork Spreader
See Page 212



Wheelie Bin Tipper
See Page 250

Steel & Plastic Drum Lifter & Rotator

- This drum lifter can pickup and rotate drums with ease
- Manual foot or handle hydraulic pump for lifting
- Geared rotation using steering handle
- Worm drive handle for drum tilting



Code	Load Capacity (kg)	Lifting Height (mm)	Leg Length (mm)	Distance Between Inner Legs (mm)	Distance Between Outer Legs (mm)	Overall Size LxWxH (mm)	Unit Weight (kg)
V5106	450	1500	770	630	810	1400x1000x2100	190



Electric Drum Lifter & Rotator

These electric drum lifters pickup and rotate drums using battery electric power for both up and down and for tilting.

- Suitable for both steel and plastic drums
- Lifting Speed: 120mm per second
- Rotation Speed: 180° - 30 seconds
- Battery: 12v, 120Ah



Code	Load Capacity (kg)	Max Lift Height (mm)	Leg Length (mm)	Distance Between Legs (mm)	Overall Size LxWxH (mm)	Unit Weight (kg)
V5150	450	2300	740	630	1600x950x1920	355