

Safety Barriers & PPE

VERDEX
Incorporates **MHA**

SAFETY FIRST

*Various Safety Chains,
Barricade Tape, Traffic Cones,*



Fixed Safety Bollards

- Ideal for protecting expensive equipment and racking from possible forklift damage
- Great for protecting edges of roller doors from truck damage
- 3 options available however other sizes can be made to order to your particular specifications
- Powder coated finish



V7420



V7427
Tru-Bolt to suit



V7421



V7422

Code	Details	Size (mm)	Diameter (mm)	Bolt Hole Size (mm)	Base Plate Size (mm)	Unit Weight (kg)
V7420	'U' Bar High Bollard	1068x1220 (HxL)	115	22	203x203x10	29.5
V7421	'U' Bar Low Bollard	230x1220 (HxL)	115	22	203x203x10	16
V7422	Fixed Straight Bollard	915 (H)	115	22	203x203x10	10.5
V7427	Tru-Bolt Galvanised 16x120mm (M16)					



Safety Bollards (Concrete Fillable)

- Ideal for protecting expensive equipment and racking from possible forklift damage
- Great for protecting edges of roller doors from truck damage
- 2 options available however other sizes can be made to order to your particular specifications
- The 1200mm high bollards (V7425 & V7426) can be concrete filled
- Available in Galvanised and Powder coated options
- Wall thickness: 3mm



Removable cap which allows bollards to be concrete filled if required



V7426



V7425



V7427
Tru-Bolt to suit

Code	Details	Height (mm)	Diameter (mm)	Bolt Hole Size (mm)	Base Plate Size (mm)	Unit Weight (kg)
V7425	Galvanised Bollard	1200	165	17	280x280x10	22
V7426	Powdercoated Yellow Bollard	1200	165	17	280x280x10	22
V7427	Tru-Bolt Galvanised 16x120mm (M16)					



Safety Guard Rail Fencing

- Protect expensive equipment from forklift damage using bolt together post and panel modular system
- Heavy duty powder coat yellow steel construction
- Easily assembled and disassembled rail system
- Supplied with all necessary bolts and fixings
- Base Size of the post is 255x255x16mm





Double Rail



Single Rail

Corner Post Comes with bolt holes on two adjoining sides

Centre Post Comes with bold holes on two opposite sides

Base Size of the post is 255x255x16mm



V7435 -1120mm long



V7436 -1730mm long



V7437 -2340mm long

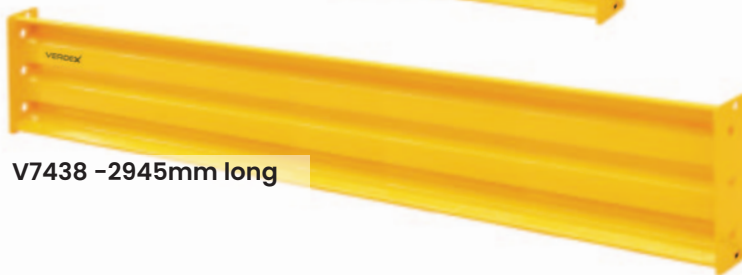

V7438 -2945mm long



V7430

V7432



V7431



V7433

Code	Description	Dimensions (mm)	Height (mm)
V7430	Single Height Corner/End Post	100x100	470
V7431	Single Height Centre Post	100x100	470
V7432	Double Height Corner/End Post	100x100	1085
V7433	Double Height Centre Post	100x100	1085

Code	Description	Height (mm)	Length (mm)
V7435	Safety Rail Section	370	1120
V7436	Safety Rail Section	370	1730
V7437	Safety Rail Section	370	2340
V7438	Safety Rail Section	370	2945



Pedestrian Handrail Barrier System

Our modular pedestrian barrier system is very easy to install with 2 metre long rails to form a continuous barrier or can be cut to your desired length. The 950mm high posts simply lock together with pre-fitted couplings.

Our system uses rounded corners which allow you to have a continuous handrail along winding passage-ways and around corners.

- No welding required, easily assembled and versatile
- Made to Australian Standards AS 1428.1:2021 and AS 1657:2018
- Powder coated yellow Post and Rail
- Hot Dipped Galvanised Cast Iron Connectors and Base Flange
- Post Rails: 48 (D) x 950mm
- Horizontal Rails: 48 (D) x 2000mm
- All Post are supplied with 2 x M10 60mm Galvanised Dynabolts

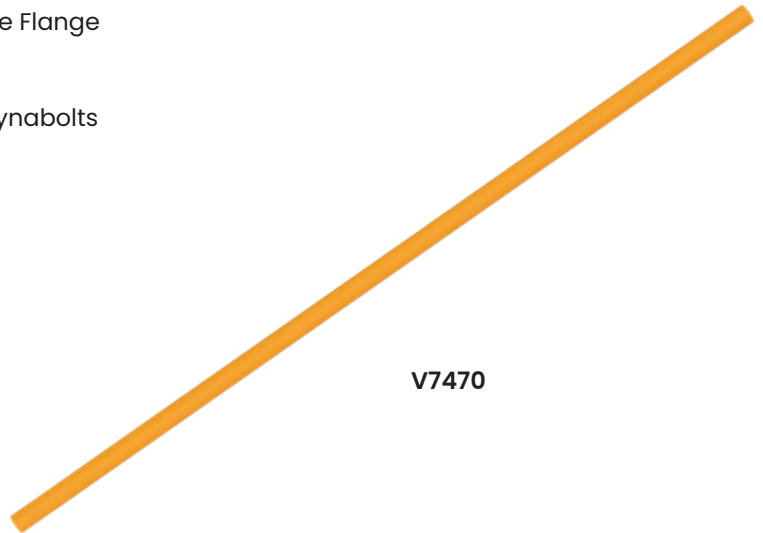

V7470

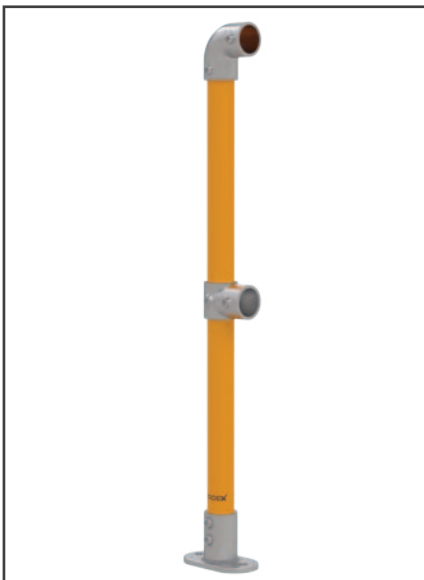

V7471 - End Post

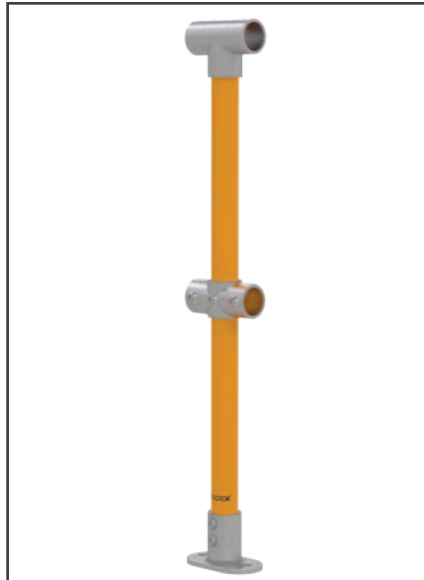

V7472 - Centre Post

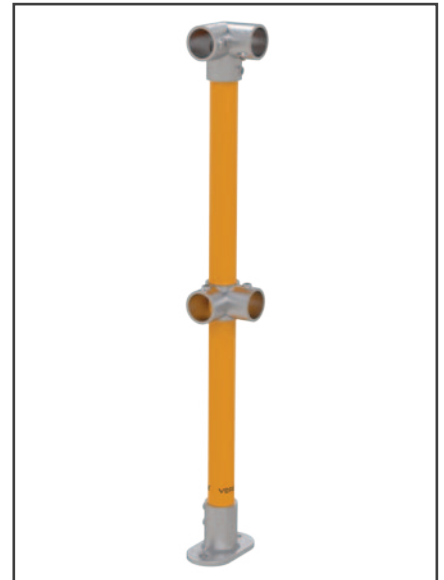

V7473 - Corner Post

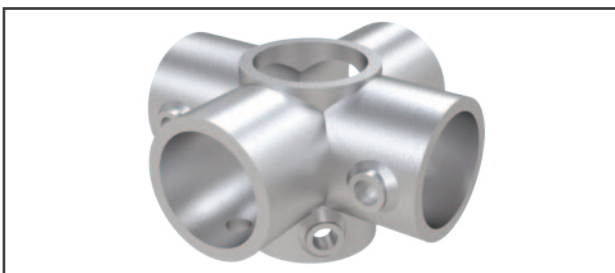

V7474 - 4 Way Center Cross Coupling Set

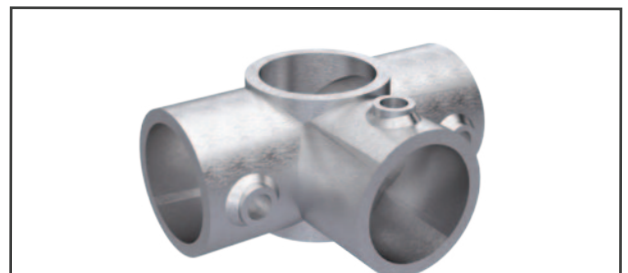

V7475 - Side Outlet Tee Set

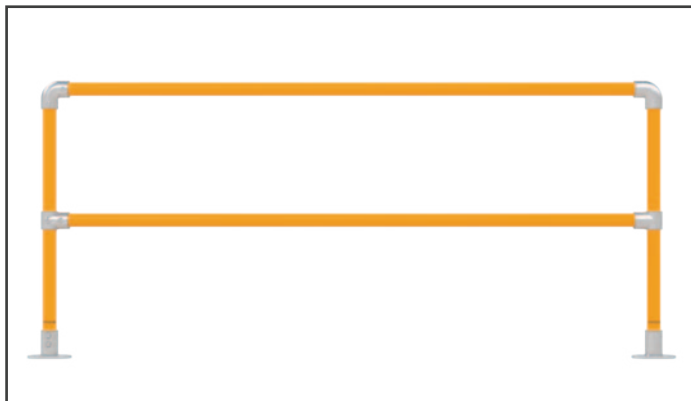

V7470 Pedestrian Rail with V7471 End Posts

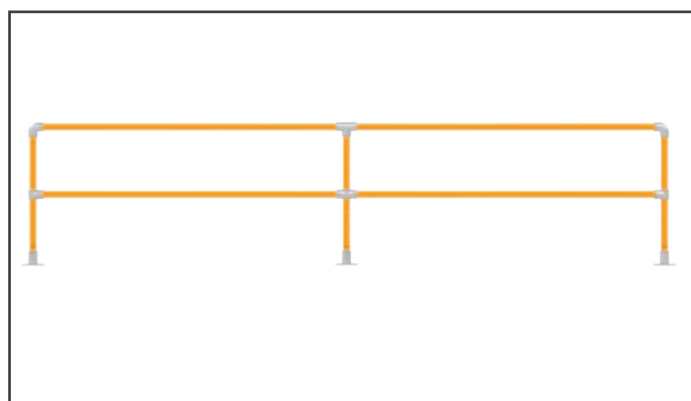

V7470 Pedestrian Rail with V7471 End Posts & V7472 Centre Posts

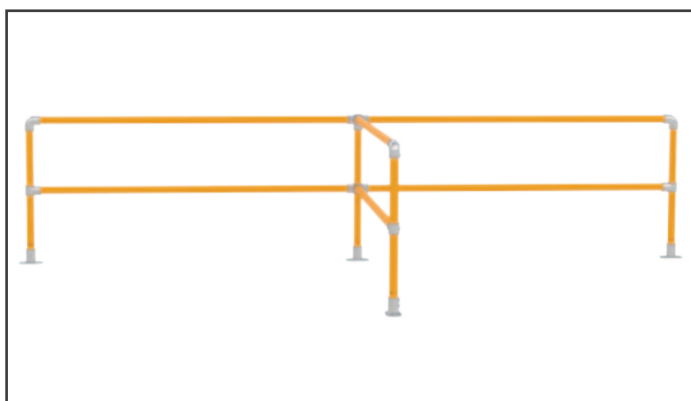

V7470 Pedestrian Rail with V7471 End Posts

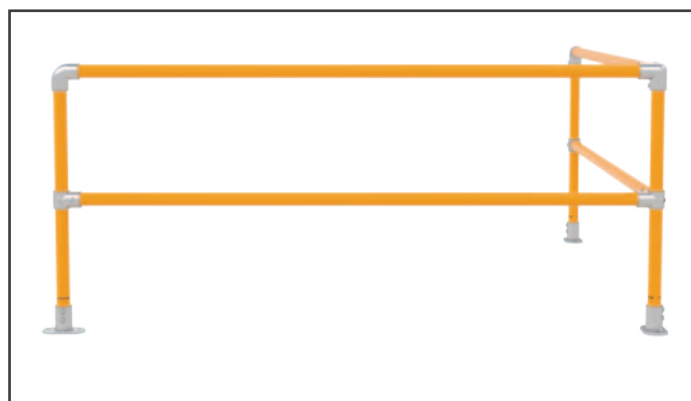
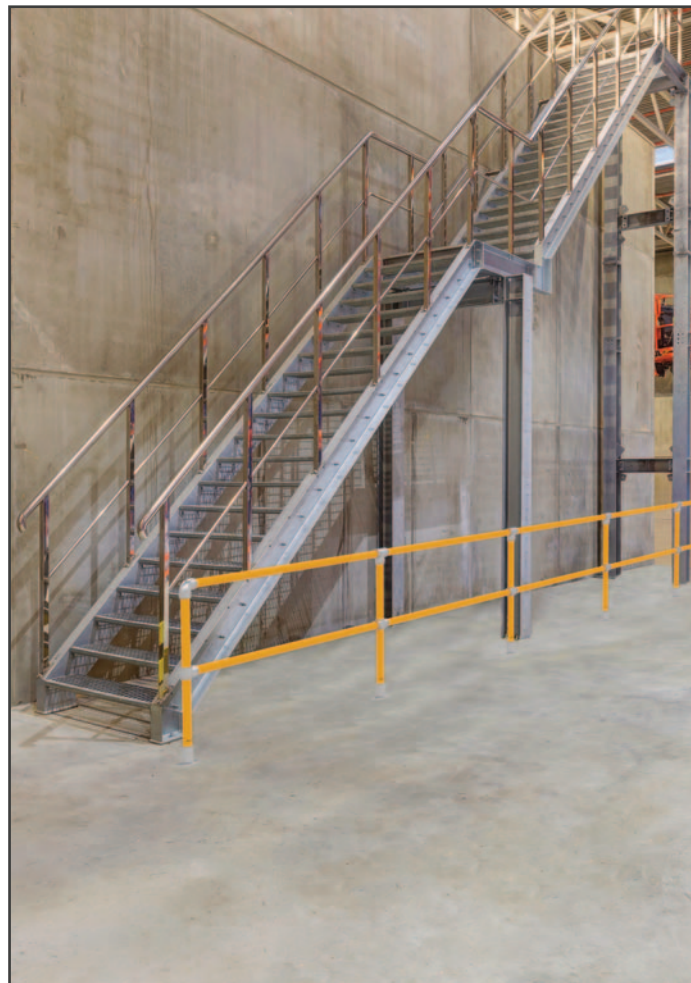

V7470 Pedestrian Rail with V7471 End Posts & V7473 Corner Posts

Code	Description	Unit Weight (kg)
V7470	2M Pedestrian Handrail (sold as a pair)	14
V7471	Pedestrian Handrail (End Post)	5.5
V7472	Pedestrian Handrail (Centre Post)	6
V7473	Pedestrian Handrail (Corner Post)	6
V7474	4 way Center Cross Coupling Set (sold as a pair of 2)	2.7
V7475	Side Outlet Tee Set (sold as a pair of 2)	2



Single Belt Retractable Post Barrier with 2m Belt

- Used as a portable crowd control and for other settings to manage and guide the flow of people.
- Consists of a retractable belt within a post, allowing for easy set up and removal.
- Black coloured Belt
- Cast Iron Black Base with Steel Cover
- Built in Rubber Floor Protectors
- Black Powder Coated Finish
- Diameter of Base: 350x25mm



V7414



V7413

Code	Length (mm)	Width of Belt (mm)	Height (mm)	Unit Weight (kg)
V7413	2000	50	1000	9.3
V7414	2000	50	1000	9.5

Wall Mount Retractable Barrier with 10m Belt

- Setting up the display is straightforward with the included hardware kit.
- Black & yellow diagonal stripes for hazard alert
- This unit offers flexibility as it includes all combinations of fixings and mounts - Retractable belt is 10m long, making it easy to section off any area
- The unit can be mounted to the wall by Magnetic, Adhesion or screws
- Available in 5m and 10m lengths

**Please Note - V7416 is too wide to fit on the front face of most standard pallet racking*

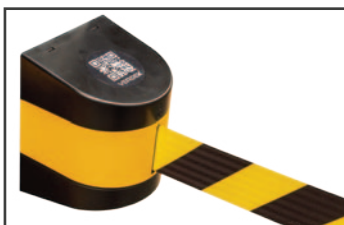

Code	Details	Length (mm)	Unit Weight (kg)
V7416	Wall Mount Retractable Barrier with 5m Belt	10,000	1
V7417	Wall Mount Retractable Barrier with 10m Belt	5000	0.6



Safety Swing Gate

- Self closing gate is designed to restrict access to areas of potential hazard
- Authorised Personnel Only sign supplied (x2)
- Adjustable to suit 830-1280mm openings
- Suits ball fence & SHS up to 50mm
- Gate swings inward
- Fits left and right hand openings, inwards opening
- Can be used with ball fence gates
- Built-in gate stop
- Self-closing stainless steel spring hinges
- Zinc Finish
- V7454 Base Plate Size: 150x150mm



V7455

V7455 pictured with
2 x V7454 (Posts to suit)

Code	Details	Overall Length (mm)	Height (mm)	Width (mm)	Unit Weight (kg)
V7455	Safety Swing Gate	910-1360	440	110	10
V7454	Post to suit V7455	-	1000	-	5

Adjustable Safety Swing Gate

- Self closing gate is designed to restrict access to areas of potential hazard
- Adjustable to suit 780-1330mm openings
- Suits ball fence & Pedestrian Handrail System
- Gate swings inward
- Fits left and right hand openings, inwards opening
- Built-in gate stop
- Heavy Duty Self-closing hinges
- Powder Coat Finish
- V7477 is supplied with 2 x Vinyl Stickers (400x300mm)



V7476

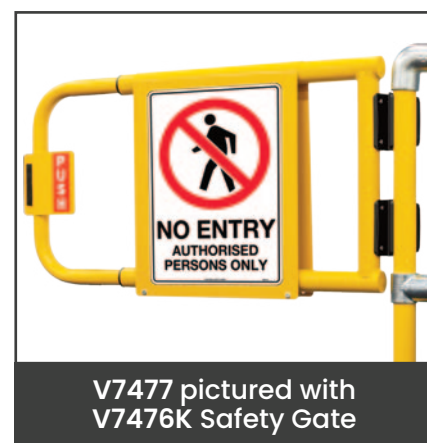

V7477

V7477 pictured with
V7476K Safety Gate

Code	Details	Overall Length (mm)	Overall Size (mm)	Unit Weight (kg)
V7476K	Adjustable Safety Gate	890 - 1440	440x50 (WxD)	11
V7477	Adjustable Safety Gate Sign Holder	-	512x425x53 (HxWxD)	4



3 Metre Expanding Barrier

- Made from powder coated steel, aluminium and high-tech plastics
- Colour: Black/Yellow
- Compact design
- Rubber castors – 4 x swivel with brakes

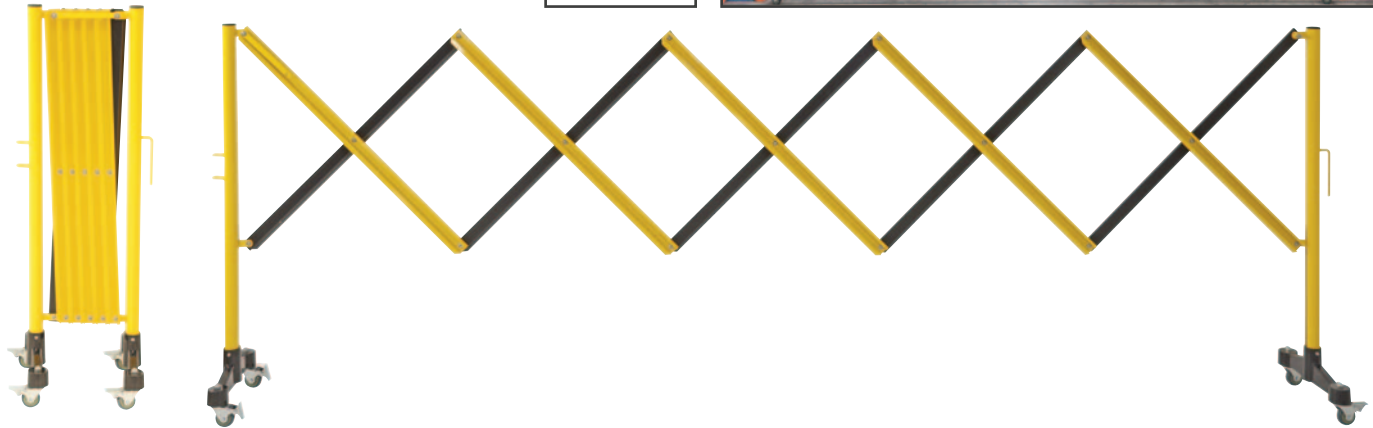
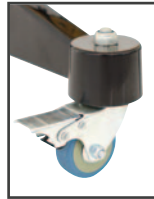

Code	Castors (mm)	Base Width (mm)	Collapsed Size LxH (mm)	Expanded Size LxH (mm)	Height with castors (mm)	Height without castors (mm)	Unit Weight (kg)
V7412	50	305	350x1030	3000x1030	1030	970	6

5 Metre Double Expanding Barrier

- Made from powder coated steel, aluminium and high-tech plastics
- Colour: Black/Yellow
- Rubber castors – 6 x swivel with brakes

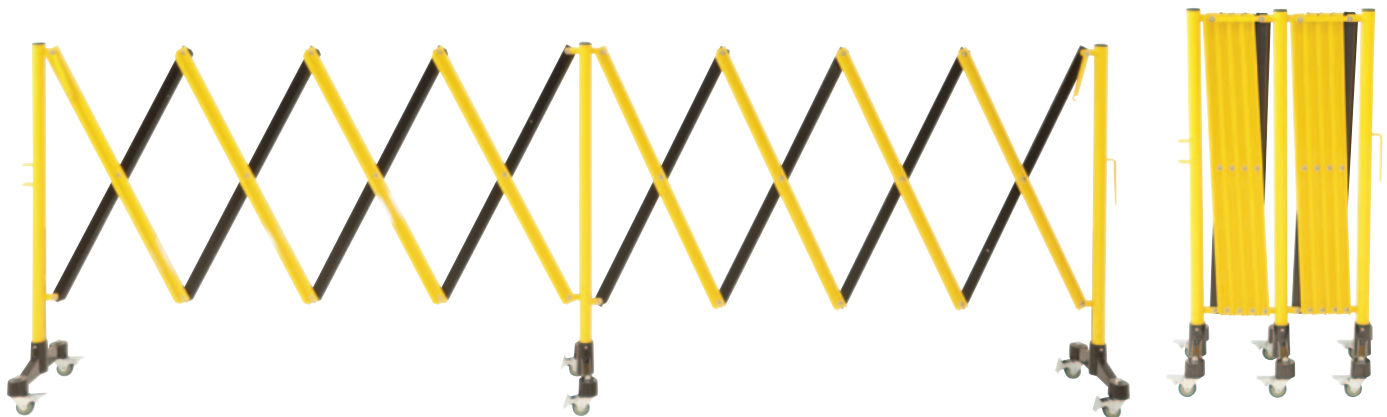
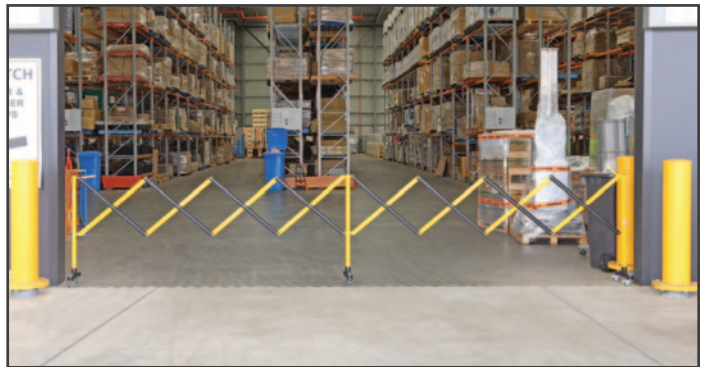
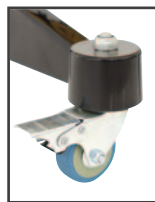

Code	Castors (mm)	Base Width (mm)	Collapsed Size LxH (mm)	Expanded Size LxH (mm)	Height with castors (mm)	Height without castors (mm)	Unit Weight (kg)
V7410	50	305	540x1030	5000x1030	1030	970	11



7.1 Metre Expanding Barrier

- Made from powder coated steel and aluminium
- Colour: Black
- Rubber castors - 8 x swivel with brakes

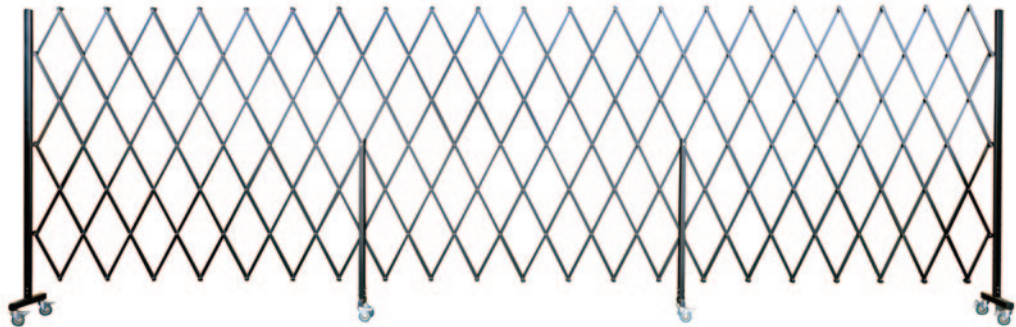
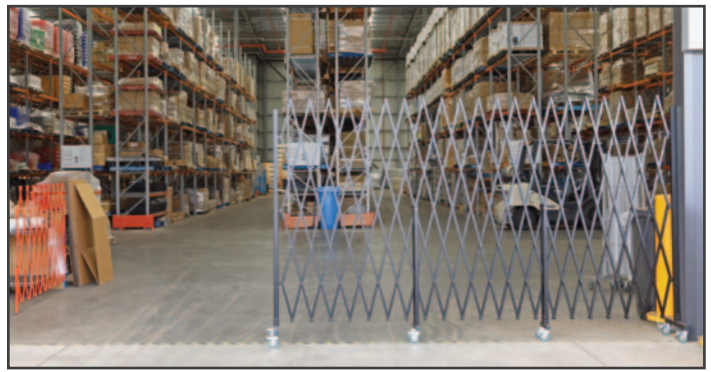
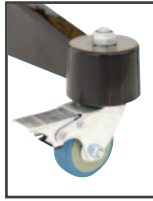

Code	Castors (mm)	Base Width (mm)	Collapsed Size LxH (mm)	Expanded Size LxH (mm)	Barrier Tube Size (mm)	Post Size (mm)	Unit Weight (kg)
V7415	75	460	560x2050	7100x1930	20x20	40x40	36

Light Weight Expanding Barrier

- Portable, lightweight and durable
- Built-in handle and locking strap for ease of handling
- Corrosion resistant
- Use indoors or outdoors
- Safety yellow and black plastic construction
- Injection moulded ABS plastic
- Width: 2.4 metres expanded (250mm closed)



Code	Height (mm)	Width expanded (mm)	Width closed (mm)	Unit Weight (kg)
V7409	970	2400	250	3



Heavy Duty Floor Angles

- Verdex's Floor Angles are durable and essential for high-traffic areas.
- Designed to prevent pallets or other items from obstructing walkways and creating damage to assets or structures
- Heavy duty steel construction
- Hole Diameter: 18mm
- Please note; 9 V7483 Screw Bolts are required for V7486, 3 for V7487 and 3 for the V7488 (purchased seperately)

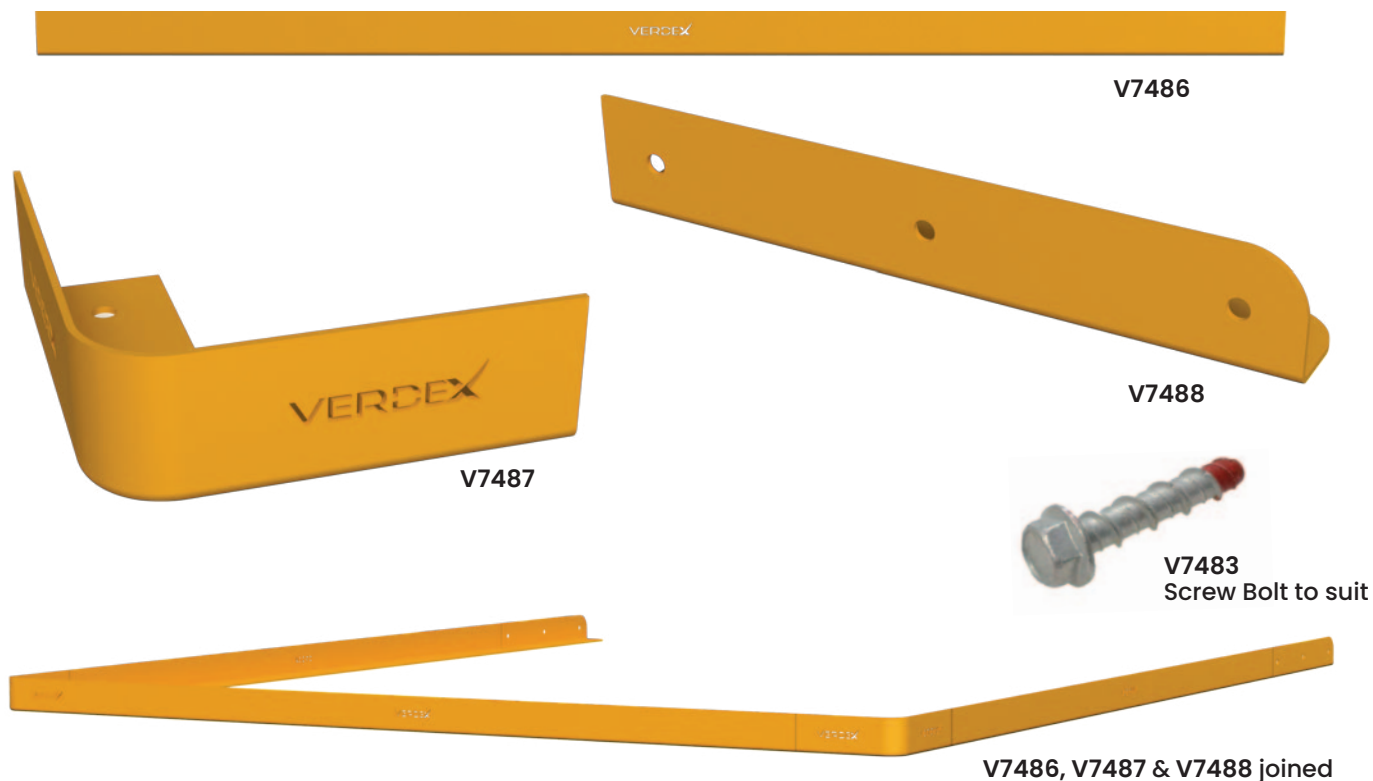

Code	Details	Overall Size (mm)	Unit Weight (kg)
V7486	Heavy Duty Floor Angle - 2.4M	2400x100x100	17.8
V7487	Heavy Duty Floor Angle (Corner)	300x300x100	3.8
V7488	Heavy Duty Floor Angle (End)	600x100x100	4.3
V7483	Galvanised Screw Bolt to suit (M12x75mm)		



Forklift Wheel Stop

- Verdex's Forklift Wheel Stops are durable and designed to enhance safety and efficiency.
- They ensure proper parking alignment, prevent damage to structures, assist with docking, and help to organize spaces effectively.
- Designed to protect assets and machinery in warehouses
- Please note; 5 V7483 Screw Bolts are required for the V7484 Wheel Stop (purchased seperately)



V7483
Screw Bolt to suit

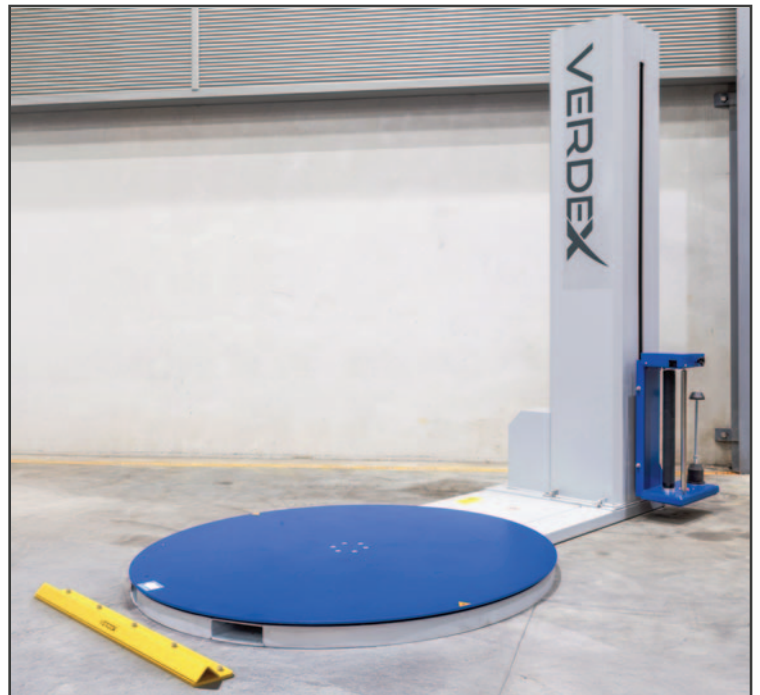
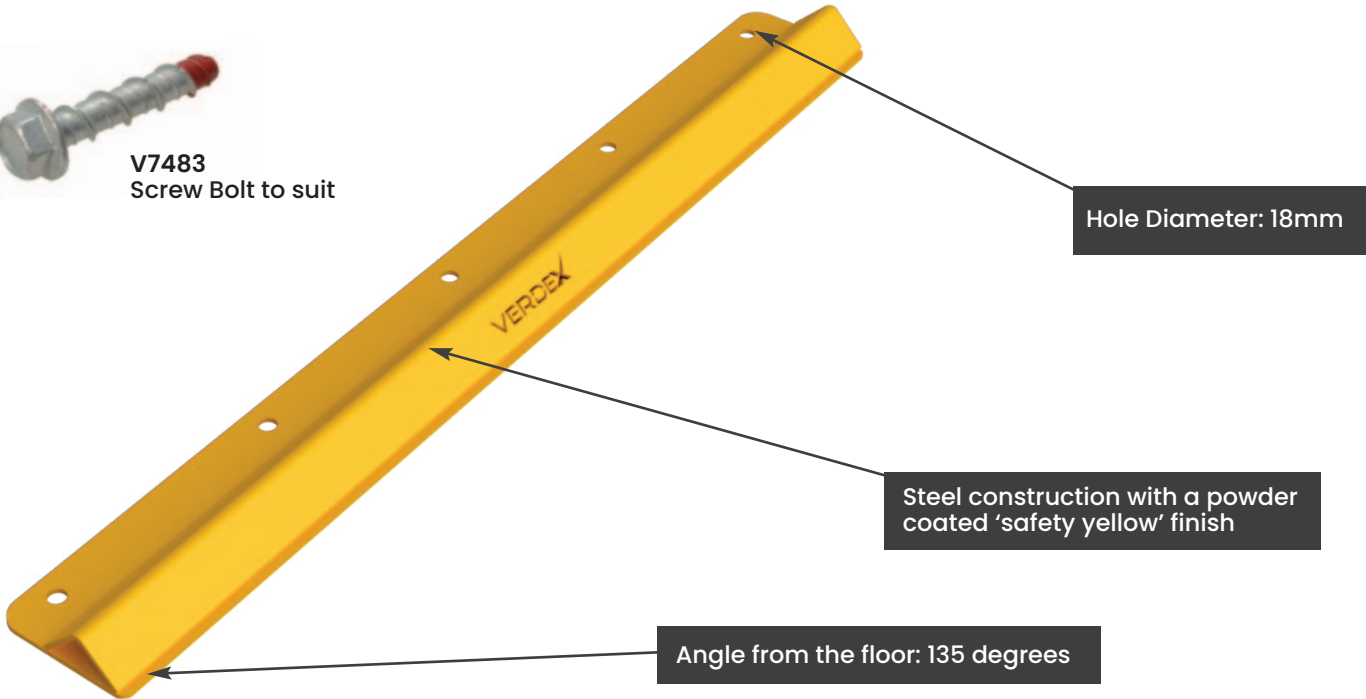

Code	Details	Size LxWxH (mm)	Hole Diameter (mm)	Unit Weight (kg)
V7484	Forklift Wheel Stop	1200x150x50	18	19
V7483	Galvanised Screw Bolt to suit (M12x75mm)			





EXPLORE OUR PPE RANGE



WE'VE GOT YOUR EARS COVERED

Hearing protection including
Ear plugs, Dispensers & Muffs



ALL EYEWEAR
PROTECTION
IS CERTIFIED TO
AS/NZS
1337.1:2010



HEADS UP!

Assorted Hard hats,
Safety goggles, Safety
glasses & face protection



GLOVES FOR ALL APPLICATIONS

A range of gloves including
Ventilated, PVC, Polycotton,
Liner, Nitrile & Nylon



GLOVE
CLIP KEEPERS
ALSO AVAILABLE

SAFETY FIRST

Various Safety Chains,
Barricade Tape, Traffic Cones,
Safety Tags & Bunting



GEARED UP

Gear up with our new range of Protective
Wear including Rain Coats with Pants,
Hi-Vis Vests & Respirators



SCAN TO VIEW OUR
FULL RANGE ONLINE:





Barricade Tape

- Barricade Tape is used to alert passersbys of an area or situation containing a possible hazard
- 100 metre roll x 75 mm width
- Heavy Duty Plastic
- Qty/Pack - 5

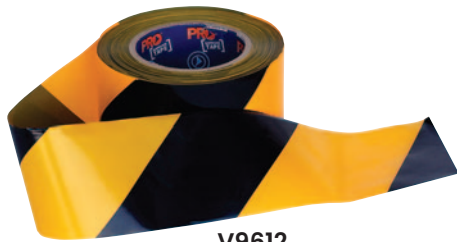

V9612

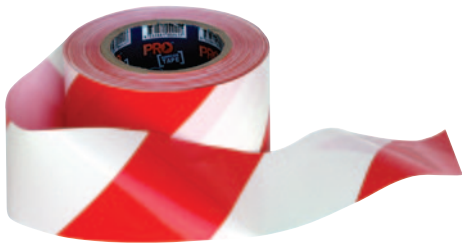

V9611



Code	Details
V9611	Barricade Tape - Red/White
V9612	Barricade Tape - Black/Yellow

Bunting

- Hi-Vis is fluoro PVC triangle flags
- 30 metre length
- Reusable high strength nylon rope
- 45 flags
- Sold Individually
- Provides excellent visibility for hazardous areas



Code	Details
V9613	Hi -Vis Bunting



T-Top Bollards

- Fluoro red post with reflective tape
- Heavy weight Rubber base
- Complies to relevant Australian Standards



Code	Details	Overall Height (mm)	Rubber Base Weight (kg)
V7450	T-Top Plastic Bollard (Base & Top)	1150	6
V7451	T-Top Bollards Top Only		

Traffic Cone - Extension bar

- Made from exterior grade ABS plastic and UV stabilised to withstand temperature extremes and sunlight
- Extendable bar starts at 135cm, extending to 210cm long as required
- Includes simple twist lock system at required length
- Features 4 yellow reflective bands for added visibility
- Sold Individually
- Includes soft durable rubber loops on both ends for easy attachment to traffic cones and bollards

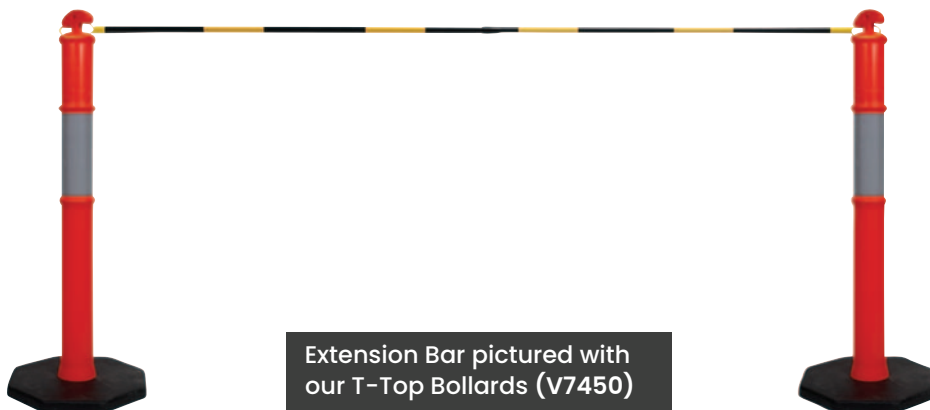

Code	Details
V9614	Traffic Cone Extension Bar



Traffic Cones

- Lightweight yet durable Traffic Cones, that can used in a variety of settings road works, construction sites and parking lots.
- High quality orange PVC
- Sold Individually



V9616

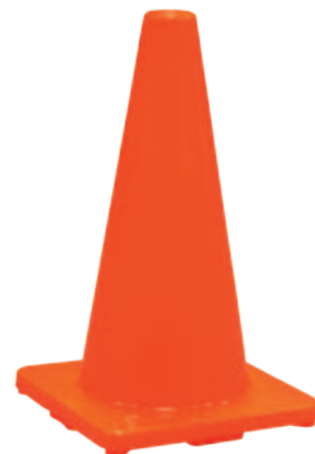

V9615

Code	Details
V9615	Traffic Cone - 450mm high
V9616	Traffic Cone - 700mm high

Traffic Cones – with Reflective Tape

- Lightweight yet durable Traffic Cones, that can used in a variety of settings road works, construction sites and parking lots.
- High quality orange PVC
150mm reflective tape complies to AS/NZS 1906.1:2007 standards
- High intensity reflective tape
- Providing even greater visibility
- Sold individually

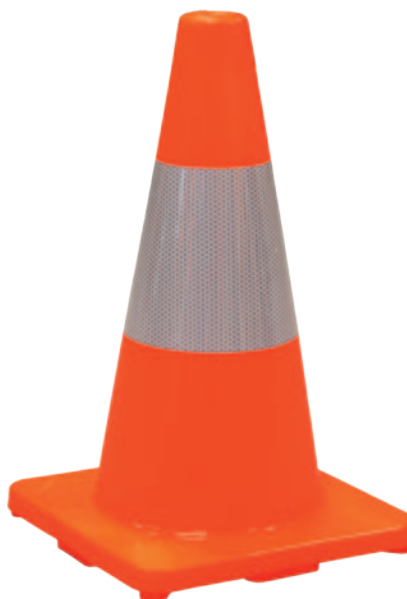

V9617



V9618

Code	Details
V9617	Traffic Cone with Reflective Tape - 450mm high
V9618	Traffic Cone with Reflective Tape - 700mm high



Footprint Floor Marking Stickers

Footprint floor marking is commonly used in numerous industrial and commercial applications to improve safety, organization, and efficiency.

They help in segregating pedestrian walkways from vehicle paths, thus reducing the risk of accidents. This is mostly important in areas where forklifts or other machinery are being used.

- Sold as 5 pairs
- Material : Vinyl
- Indoor Outdoor use



Code	Overall Size LxW (mm)
V9540	254x89

Industrial 'STOP' Floor Marking Stickers

Industrial 'STOP' floor marking is used to improve safety and organization in industrial environments including factories, warehouses, and manufacturing facilities.

These markings are especially significant in areas with high foot or vehicle traffic, intersections, or areas of potential hazard.

- Sold as a pair
- Material : Vinyl
- Indoor and Outdoor use

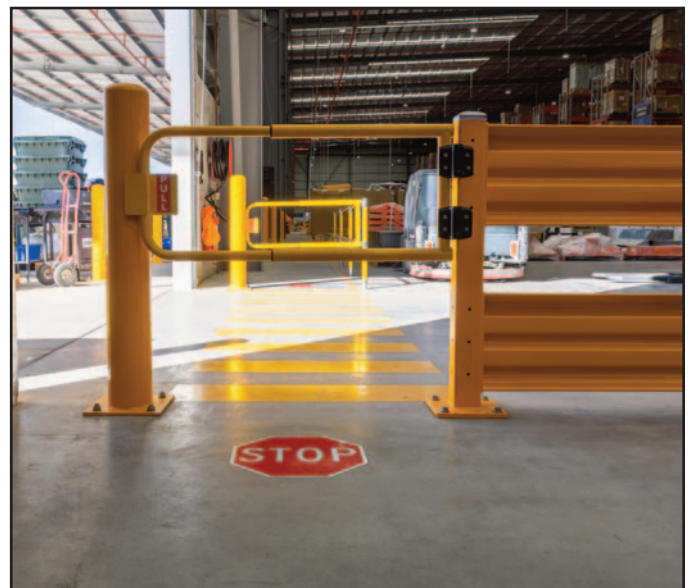

Code	Overall Size (mm)
V9541	400x400

WE'VE GOT YOUR SIGNAGE NEEDS COVERED ...



Various Keep Clear, No Entry & No Admittance signs perfect for a range of applications



Protective Equipment
signage to promote
workplace safety



Range of instructional signs suitable for areas which specific rules & restrictions apply

Signage to guide pedestrians
& warn of any potential hazards.
Suitable for a range of environments



VIEW OUR FULL RANGE ONLINE:

verdex.com.au/safety-barriers-ppe-signage/signage/

Safety Tags

- Safety Tags are used to prevent accidental injury or illness to employees who are exposed to hazardous conditions that may be unexpected.
- 125mm x 75mm
- Non tear/all weather
- Qty/Pack - 100 Tags



V9619

V9620

Code	Details
V9619	Safety tags - Danger
V9620	Safety tags - Out of Service

Safety Chains

- A high strength plastic safety and barrier chain which can be used to cordon off work place and public access areas
- Provides excellent visibility for hazardous areas
- UV stabilised
- Available in Safety yellow colour and Red & White
- 8mm thick plastic loops
- Sold per 25 metre roll

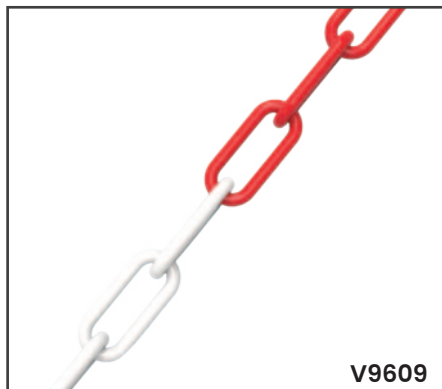

V9609

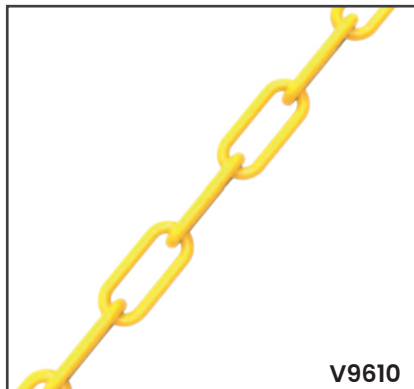

V9610



Code	Details
V9609	Safety Chain - Red/White
V9610	Safety Chain - Yellow



Heavy Duty Wheel Chock Trolley

- These units are a great addition for loading docks, depots or parking areas.
- Finish: Powder coat Yellow
- V1213 Capacity: 6 Heavy Duty Rubber Wheel Chocks (V7847)
- V1214 Capacity: 2 Heavy Duty Rubber Wheel Chocks (V7847)
- Fitted with 2 Wheel Chock Holder (V7847)
- Optional add-on Holder is available (V1214)
- 200mm Rubber Wheels

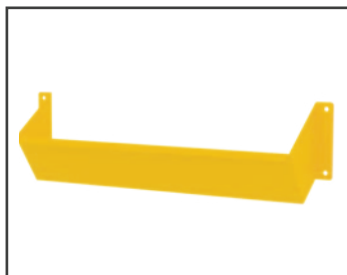

V1214 Wheel Chock Holder



V1213 Wheel Chock Trolley



Code	Details	Overall Size LxWxH (mm)	Unit Weight (kg)
V1213	Wheel Chock Trolley	815x475x1130	16
V1214	Wall Mounted Wheel Chock Holder	570x110x115	1

Heavy Duty Rubber Wheel Chock

- The Heavy Duty Rubber Wheel Chocks are designed to prevent unintentional movement of vehicles, especially when they are parked or stationary.
- These Wheel Chocks can be used for various applications such as maintenance, loading/unloading, truck/trailer parking, boat trailers, construction sites.
- Manufactured from 100% recycled rubber
- Superior construction ensures the wheel chocks will not warp, crack, chip or rot
- Rope Material: Yellow Darcon
- Rope Length: 1000mm
- These Wheel Chocks are sold as 2/carton



Code	Size LxWxH (mm)	Unit Weight (kg)
V7847	285x250x185	6.5



R2 Response Plus First Aid Kits

- Complies with WHS 2019 Regulations for Workplaces, high risk 1-25 persons.
- Ideal general purpose First Aid Kit for any application.
- Includes Eye 'n' Wound, Burn and Outdoor modules for catering to specific injury risks in these areas.
- Available in 3 case options to suit almost any application in the workplace.
- Dimensions (WxHxD): 285x420x130mm

Scan here to view the First Aid Pack contents online



V9532



V9531



V9533

Code	Details
V9531	Response Plus First Aid Kit, Metal Wall Mount
V9532	Response Plus First Aid Kit, Soft Pack
V9533	Response Plus Kit Refill Pack



R4 Medic First Aid Kits

- Complies with WHS 2019 Regulations for Workplaces, high risk 1-50 persons.
- One of the biggest and best in our R4 range, especially suited to first aid rooms, etc.
- Additional modules to make contents easily locatable.
- Available in 2 case options to suit almost any application in the workplace
- Hospital-grade content to provide an effective response to injuries.
- Dimensions (WxHxD): 410x575x130mm

Scan here to view the First Aid Pack contents online



V9535



V9534



V9536

Code	Details
V9534	Constructa Medic Kit, Metal Wall Mount
V9535	Constructa Medic Kit, Soft Pack
V9536	Constructa Medic Refill Kit

